

BODY SECTION

This service manual has been prepared to provide SUBARU service personnel with the necessary information and data for the correct maintenance and repair of SUBARU vehicles.

This manual includes the procedures for maintenance, disassembling, reassembling, inspection and adjustment of components and diagnostics for guidance of experienced mechanics.

Please peruse and utilize this manual fully to ensure complete repair work for satisfying our customers by keeping their vehicle in optimum condition. When replacement of parts during repair work is needed, be sure to use SUBARU genuine parts.

All information, illustration and specifications contained in this manual are based on the latest product information available at the time of publication approval.

**HVAC SYSTEM
(HEATER, VENTILATOR AND A/C)** AC

**HVAC SYSTEM (AUTO A/C)
(DIAGNOSTICS)** AC

AIRBAG SYSTEM AB

AIRBAG SYSTEM (DIAGNOSTICS) AB

SEAT BELT SYSTEM SB

LIGHTING SYSTEM LI

WIPER AND WASHER SYSTEMS WW

ENTERTAINMENT ET

COMMUNICATION SYSTEM COM

GLASS/WINDOWS/MIRRORS GW

BODY STRUCTURE BS

INSTRUMENTATION/DRIVER INFO IDI

SEATS SE

SECURITY AND LOCKS SL

IMMOBILIZER (DIAGNOSTICS) IM

**SUNROOF/T-TOP/CONVERTIBLE TOP
(SUNROOF)** SR

EXTERIOR/INTERIOR TRIM EI

BODY SECTION

EXTERIOR BODY PANELS

EB

CRUISE CONTROL SYSTEM

CC

**CRUISE CONTROL SYSTEM
(DIAGNOSTICS)**

CC

AIRBAG SYSTEM (DIAGNOSTICS)

AB

	Page
1. Basic Diagnostic Procedure	2
2. Check List for Interview	3
3. General Description	4
4. Electrical Components Location.....	17
5. A/B Control Module I/O Signal	19
6. Airbag Connector	26
7. Airbag Warning Light Illumination Pattern.....	28
8. Read Diagnostic Trouble Code	29
9. Inspection Mode.....	30
10. Clear Memory Mode.....	31
11. Airbag Warning Light Failure.....	33
12. List of Diagnostic Trouble Code	38
13. Diagnostic Chart with Trouble Code	42

BASIC DIAGNOSTIC PROCEDURE

AIRBAG SYSTEM (DIAGNOSTICS)

1. Basic Diagnostic Procedure

A: PROCEDURE

	Step	Check	Yes	No
1	Read Diagnostic Trouble Code. <Ref. to AB-29, Read Diagnostic Trouble Code.>	Is the normal code being detected?	Finish the diagnosis.	Go to step 2.
2	Read Diagnostic Trouble Code. <Ref. to AB-29, Read Diagnostic Trouble Code.>	Is the trouble code being detected?	Go to step 3.	Go to "Airbag Warning Light Failure".<Ref. to AB-33, Airbag Warning Light Failure.>
3	Perform the diagnosis. 1)Judge the possible cause from "List of Diagnostic Trouble Code" <Ref. to AB-38, List of Diagnostic Trouble Code.> . 2)Inspect using "Diagnostic Chart with Trouble Code". (DTC) 3)Repair the cause of the trouble. 4)Perform the clear memory mode. <Ref. to AB-31, Clear Memory Mode.> 5)Perform the inspection mode. <Ref. to AB-30, Inspection Mode.> 6)Read diagnostic trouble code.	Is the trouble code being detected?	Perform the procedure 1) to 5) in step 3.	Finish the diagnosis.

CHECK LIST FOR INTERVIEW

AIRBAG SYSTEM (DIAGNOSTICS)

2. Check List for Interview

A: CHECK

Customer's Name		Inspector's Name	
Date Vehicle Brought In	/ /	Registration No.	
Odometer Reading	Km Miles	Vin No.	
Date Problem Occurred	/ /	Registration Year	/ /
Weather	<input type="checkbox"/> Fine <input type="checkbox"/> Cloudy <input type="checkbox"/> Rainy <input type="checkbox"/> Snowy <input type="checkbox"/> Other:		
Temperature	°C (°F)		
Road Condition	<input type="checkbox"/> Level road <input type="checkbox"/> Uphill <input type="checkbox"/> Downhill <input type="checkbox"/> Rough road <input type="checkbox"/> Others:		
Vehicle Operation	<input type="checkbox"/> Starting <input type="checkbox"/> Idling <input type="checkbox"/> Driving (<input type="checkbox"/> Constant Speed <input type="checkbox"/> Acceleration <input type="checkbox"/> Deceleration <input type="checkbox"/> Steering wheel turn <input type="checkbox"/> Other:)		
Details of Problem			
Check Airbag Warning Light	<input type="checkbox"/> Remains ON <input type="checkbox"/> Remains OFF		
Check DTC	<input type="checkbox"/> Normal Code <input type="checkbox"/> Trouble Code: (Code:)		

GENERAL DESCRIPTION

AIRBAG SYSTEM (DIAGNOSTICS)

3. General Description

A: CAUTION

- When servicing a vehicle, be sure to turn the ignition switch OFF, disconnect the ground cable from the battery, and wait for more than 20 seconds before starting work.
- The airbag system is fitted with a backup power source. If the airbag system is serviced within 20 seconds after the ground cable is disconnected, it may inflate.

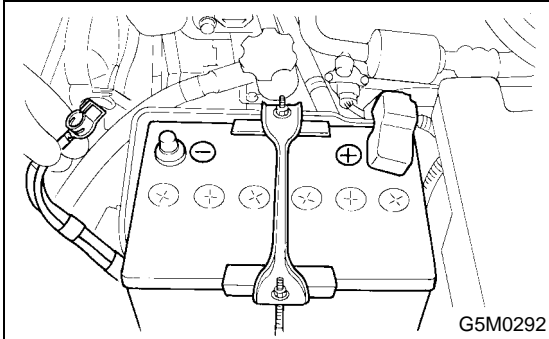

- If sensors, airbag module, airbag control module pretensioner, and harness are deformed or damaged, replace them with new genuine parts.
- Do not use the airbag system and pretensioners on other vehicles. When replacing parts, be sure to replace them with new parts.

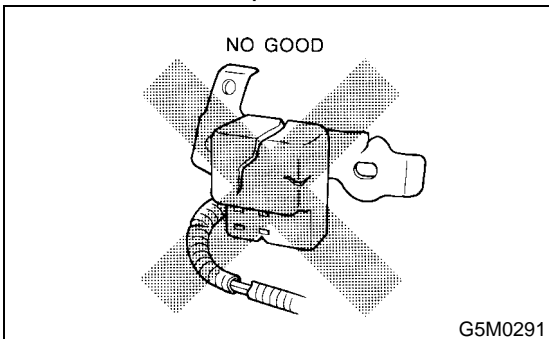

- When checking the system, be sure to use a digital circuit tester. Use of an analog circuit tester may cause the airbag to activate erroneously.

- When checking, use a test harness. Do not directly apply the tester probe to any connector terminal of the airbag.

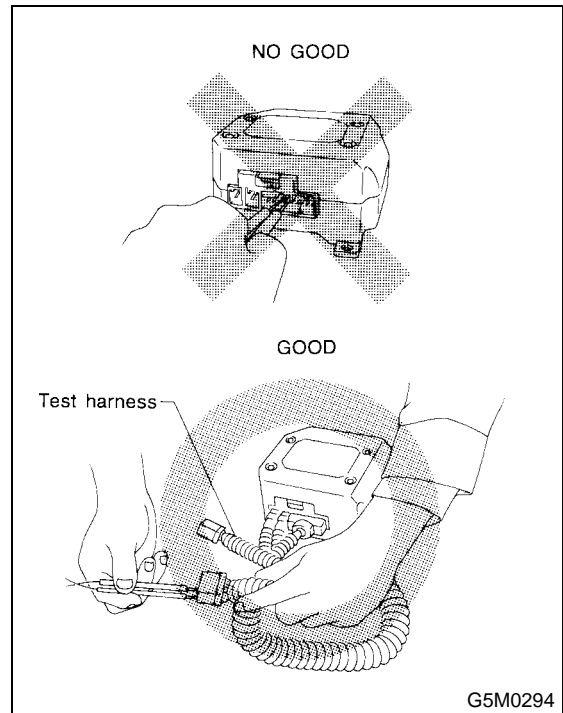
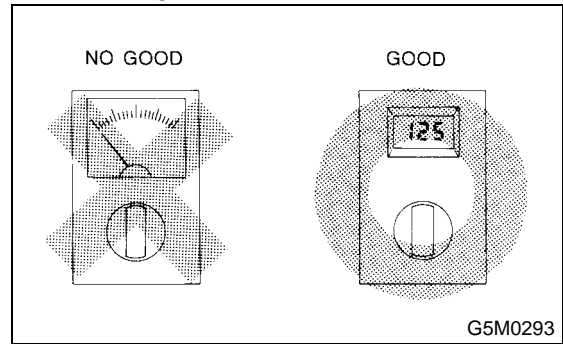

GENERAL DESCRIPTION

AIRBAG SYSTEM (DIAGNOSTICS)

- Do not drop the airbag modulator parts, subject them to high temperature over 93°C (199°F), or let water, oil, or grease get on them; otherwise, the internal parts may be damaged and reliability greatly lowered.

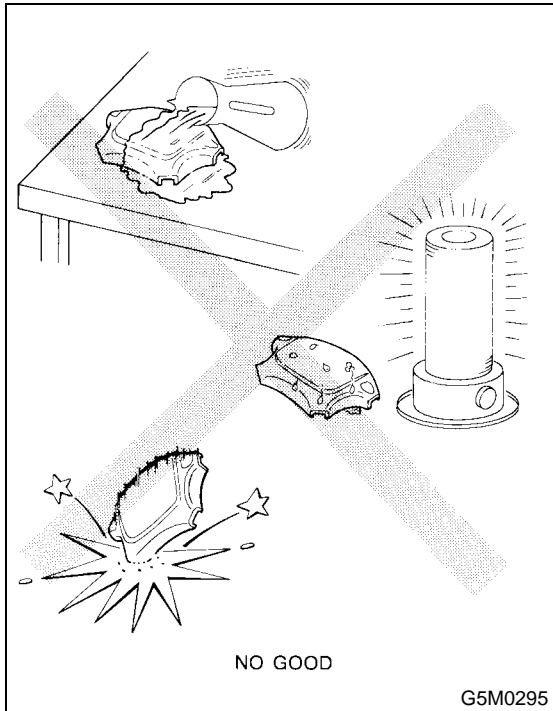

- If any damage, opening or rust is found on the airbag system wire harness, do not attempt to repair using soldering equipment. Be sure to replace the faulty harness with a new genuine part.

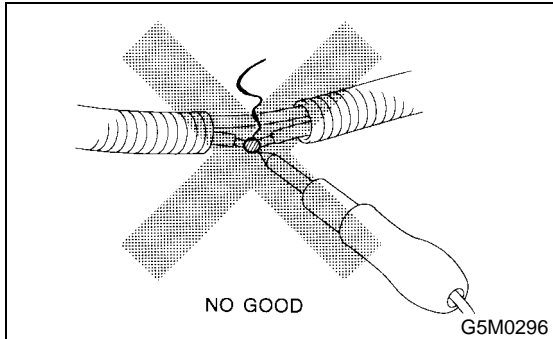

- Install the wire harness securely with the specified clips to avoid interference or tangled up with other parts.

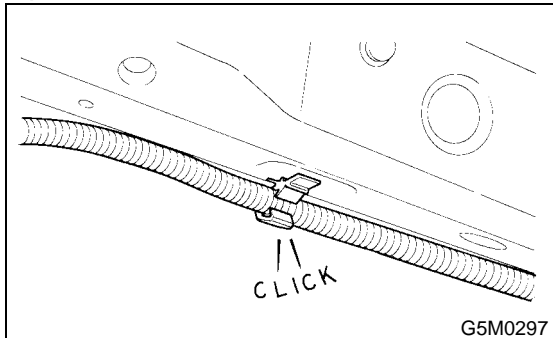

- Do not allow water or oil to come in contact with the connector terminals. Do not touch the connector terminals.

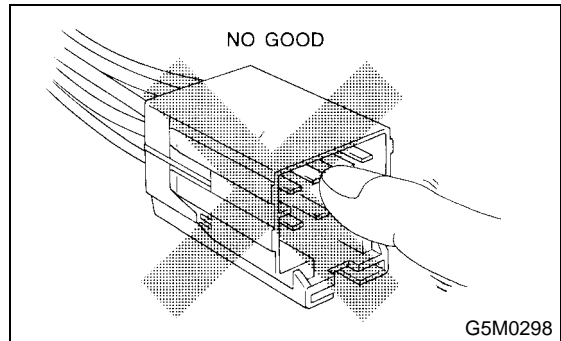

- The airbag module (driver, passenger, and side, pretensioner) must not be disassembled.
- The airbag module cannot be used again once inflated.

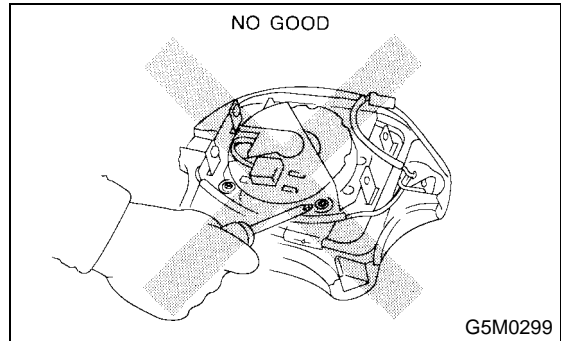

- After removal, keep the airbag module with the pad facing upward on a dry, clean, and flat surface away from heat and light sources, and moisture and dust.

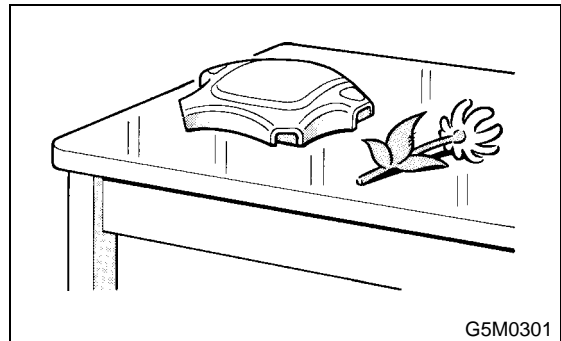

- Do not check continuity of the airbag module (driver, passenger, and side, pretensioner).

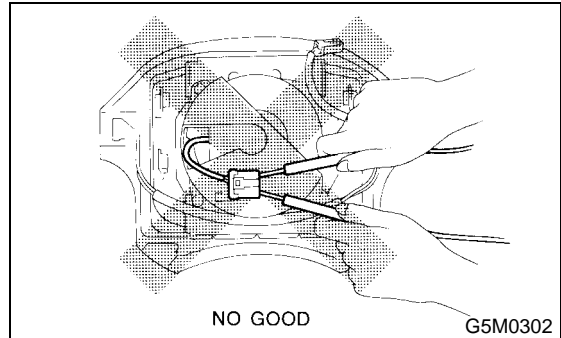

GENERAL DESCRIPTION

AIRBAG SYSTEM (DIAGNOSTICS)

- The removed front seat with the airbag module must be kept at least 200 mm (8 in) away from walls and other objects.

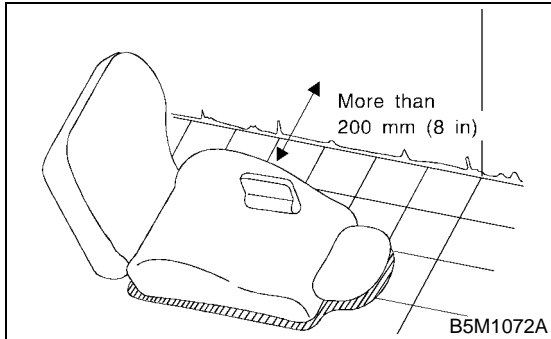

- When painting or performing sheet metal work on the front part of the vehicle, including the front wheel apron, front fender, and front side frame, remove the front sub sensors and wire harness of the airbag system.
- When painting or performing sheet metal work on the side of the vehicle, including the side sill, center pillar, and front and rear doors, remove the side airbag sensors and wire harness of the airbag system.

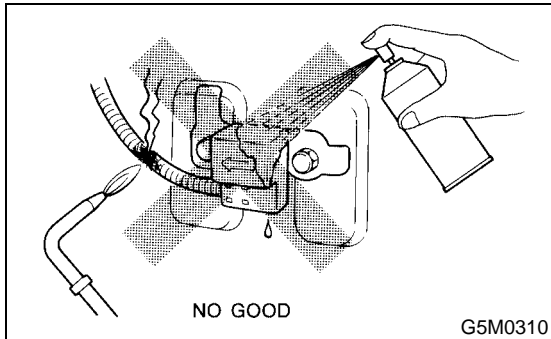

- When storing a removed airbag module, do not place any objects on it or pile airbag modules on top of each other. If the airbag inflates for some reason when it is placed with its pad side facing downward or under any object, a serious accident may result.

GENERAL DESCRIPTION

AIRBAG SYSTEM (DIAGNOSTICS)

Driver side

GOOD

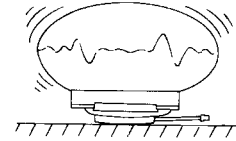

NO GOOD

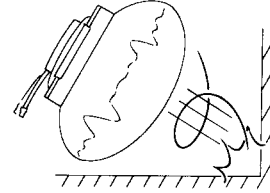
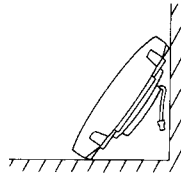

NO GOOD

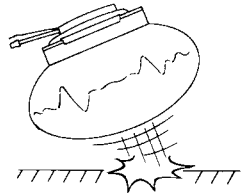
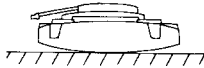

NO GOOD

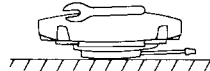

Passenger side

GOOD

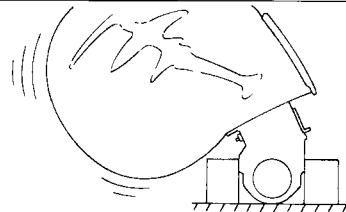
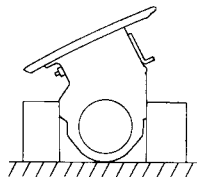
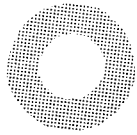

NO GOOD

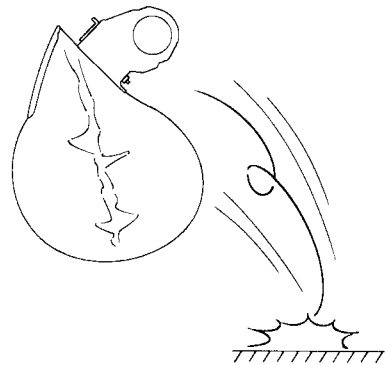
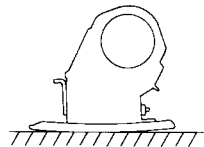

NO GOOD

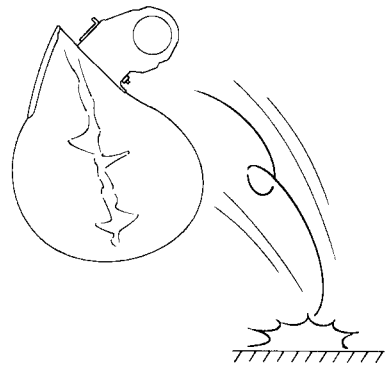
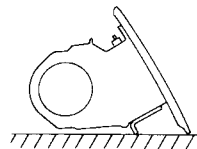

G5M0604

GENERAL DESCRIPTION

AIRBAG SYSTEM (DIAGNOSTICS)

- Do not discard undeployed airbag modules. They could easily cause a serious accident if accidentally deployed.
- Do not damage the airbag module or drop it.

B: INSPECTION

Before diagnosing, check the following items that might be related to the engine problem:

1. BATTERY

Measure battery voltage and specific gravity of electrolyte.

Standard voltage: 12V

Specific gravity: Above 1.260

GENERAL DESCRIPTION

AIRBAG SYSTEM (DIAGNOSTICS)

C: PREPARATION TOOL

CAUTION:

Be sure to use specified test harness M, F, G, H, L and I or I2 when measuring voltage, resistance, etc. of AIRBAG system component parts.

1. TEST HARNESS M

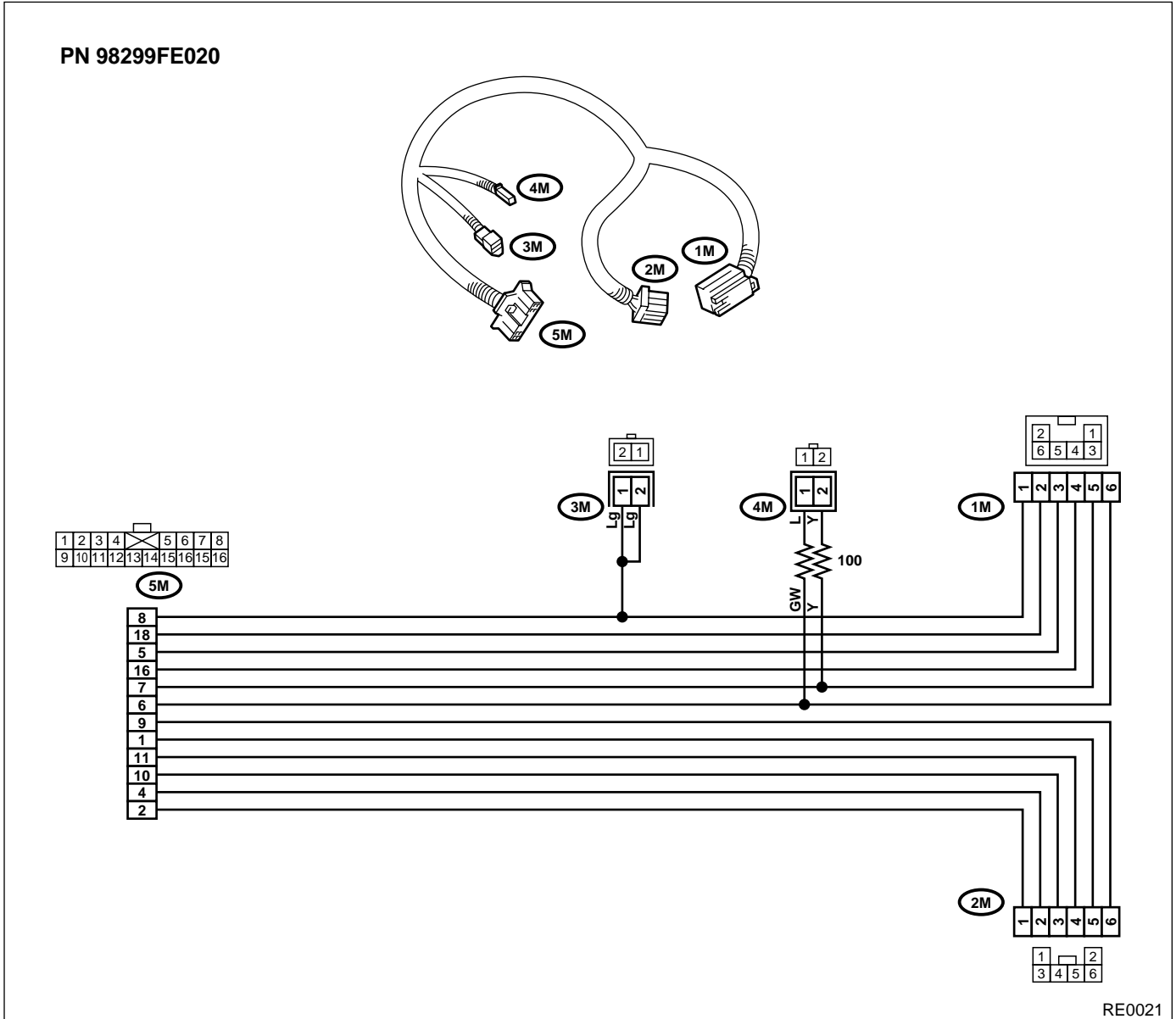

GENERAL DESCRIPTION

AIRBAG SYSTEM (DIAGNOSTICS)

2. TEST HARNESS F

PN 98299FC010

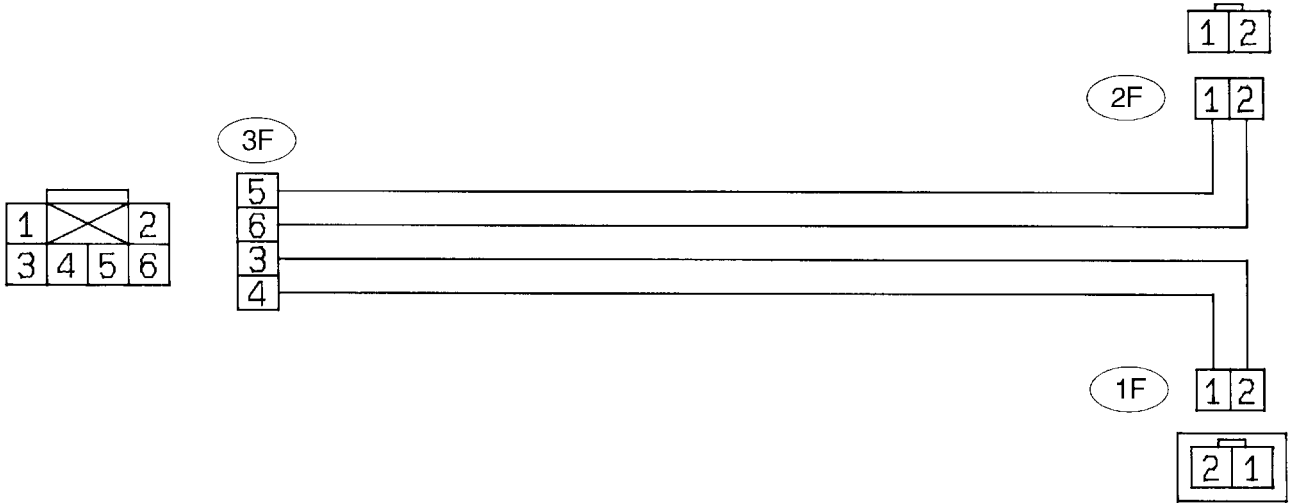
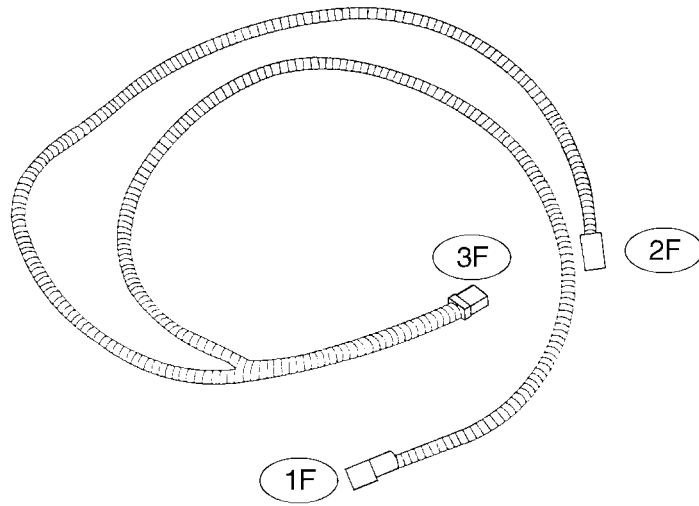

S5M0247A

GENERAL DESCRIPTION

AIRBAG SYSTEM (DIAGNOSTICS)

3. TEST HARNESS G

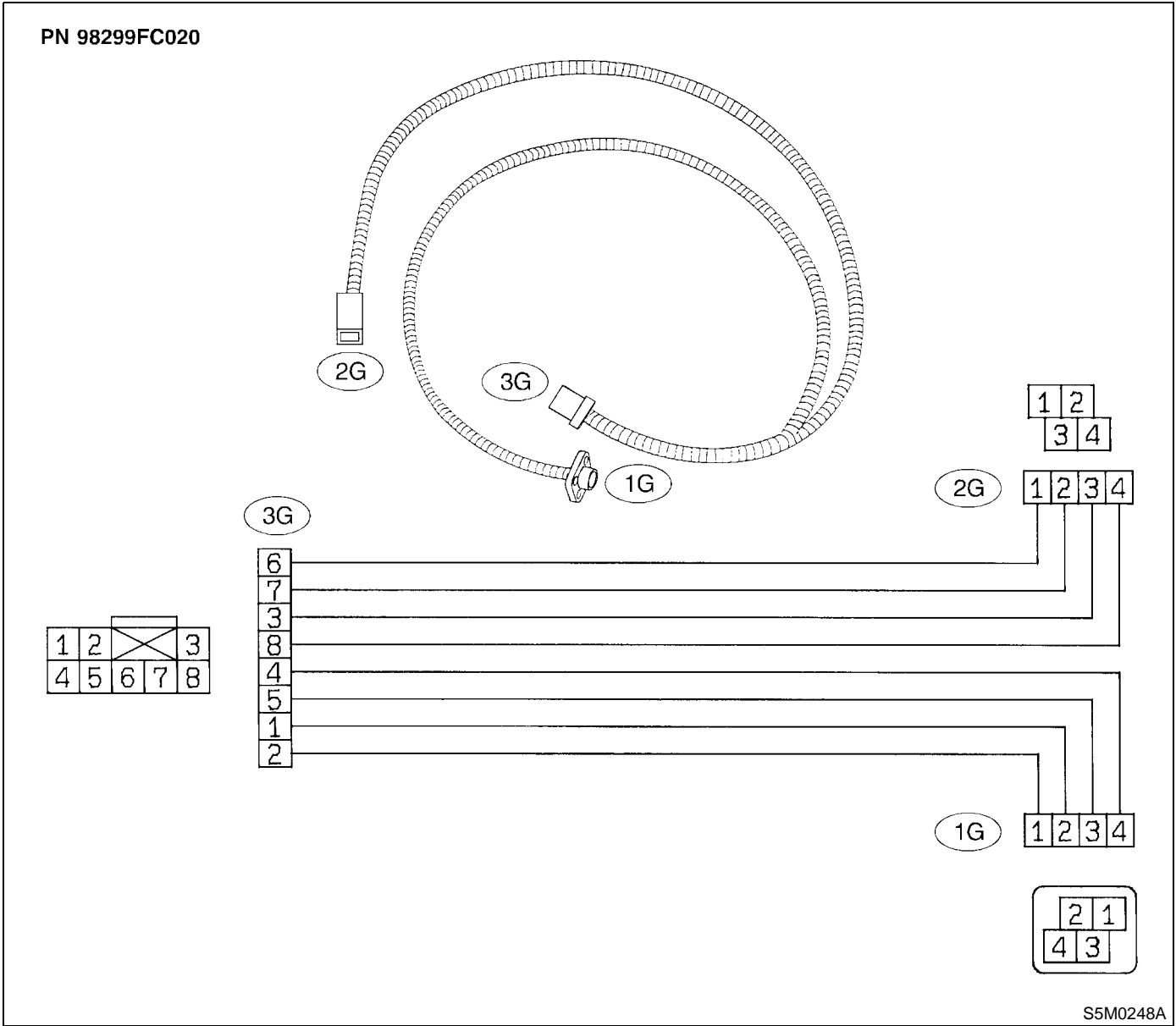

GENERAL DESCRIPTION

AIRBAG SYSTEM (DIAGNOSTICS)

4. TEST HARNESS H

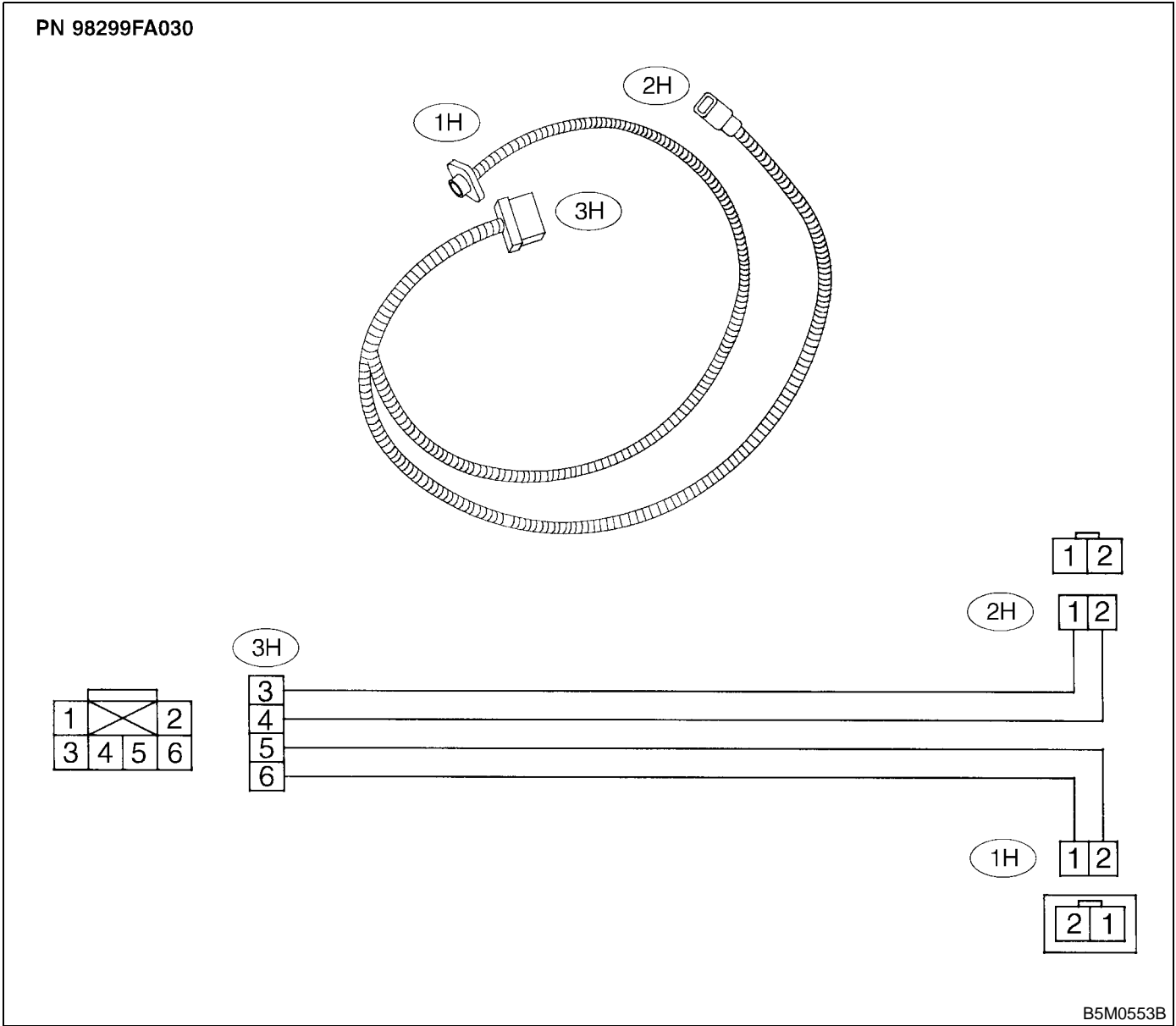

GENERAL DESCRIPTION

AIRBAG SYSTEM (DIAGNOSTICS)

5. TEST HARNESS L

PN 28299FE000

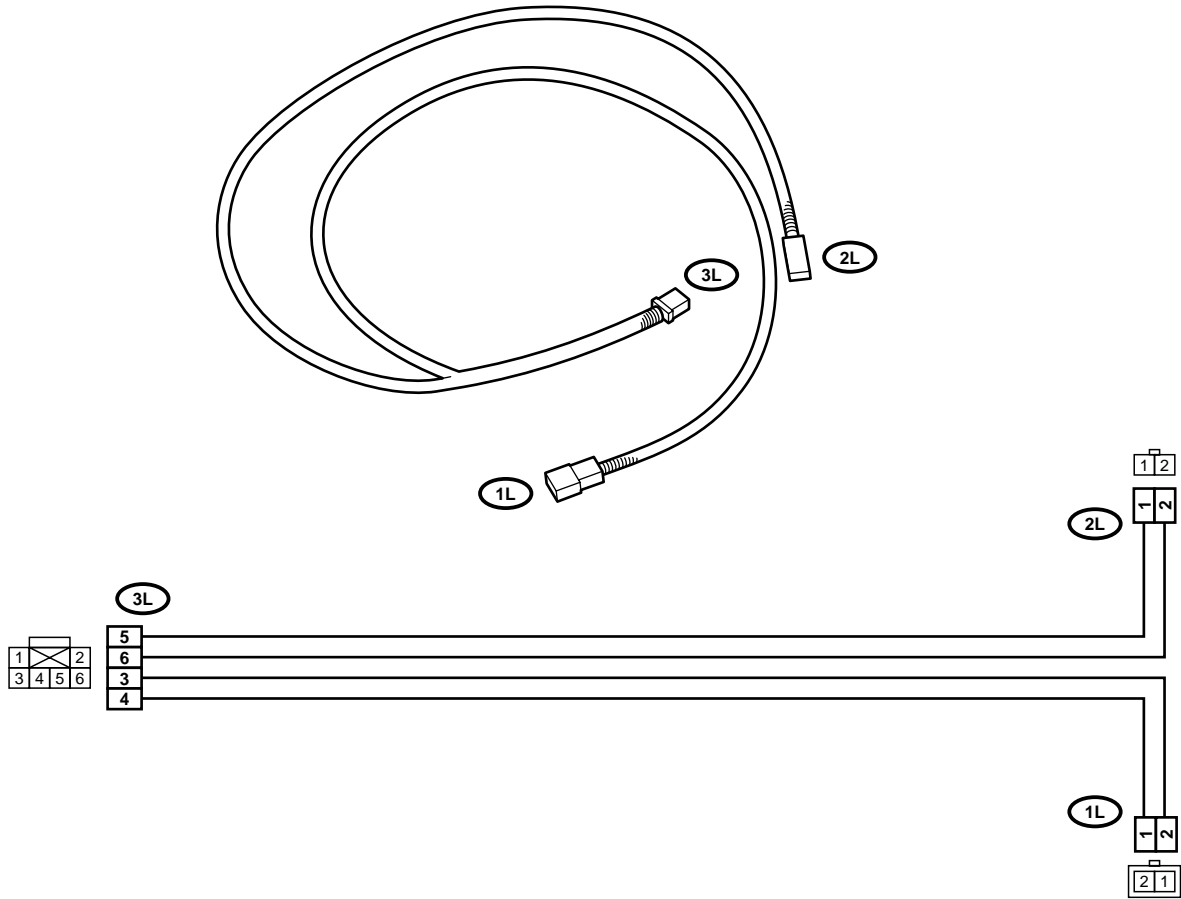

RE0022

GENERAL DESCRIPTION

AIRBAG SYSTEM (DIAGNOSTICS)

6. TEST HARNESS I

PN 98299FC040

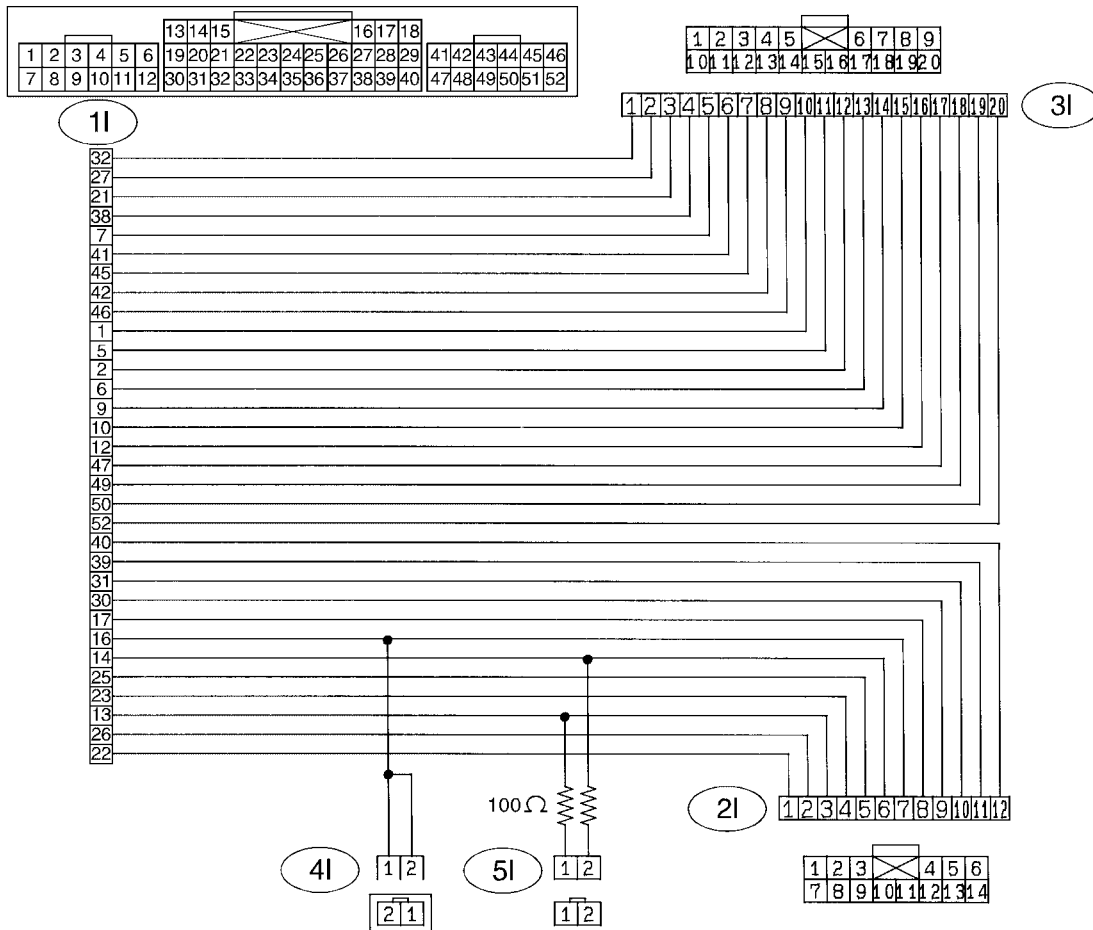
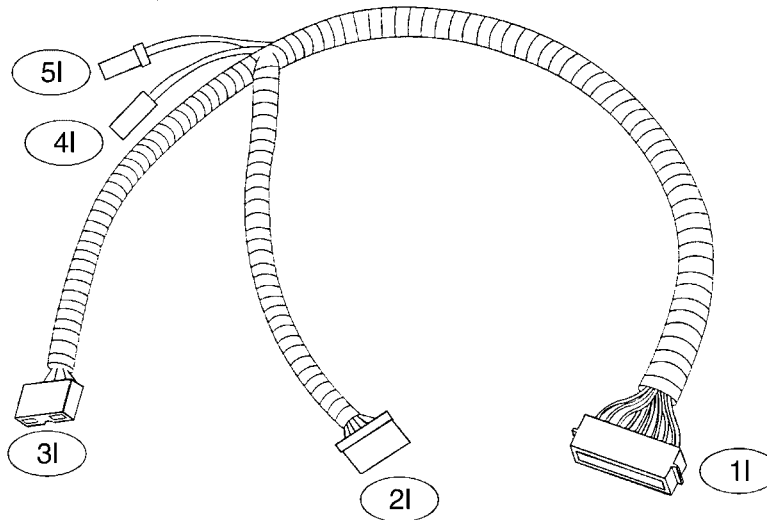

S5M0340A

GENERAL DESCRIPTION

AIRBAG SYSTEM (DIAGNOSTICS)

7. TEST HARNESS I2

PN 98299FC041

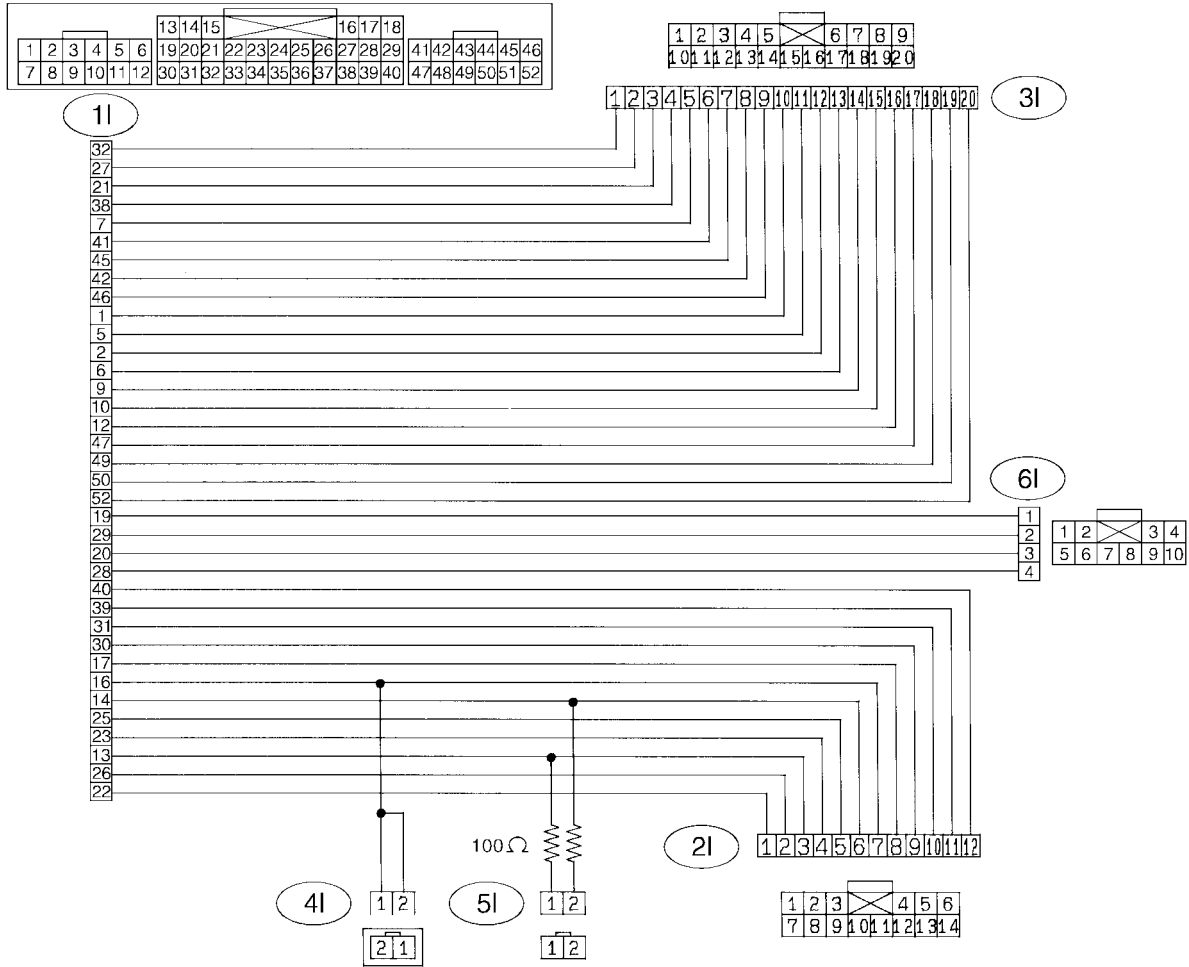
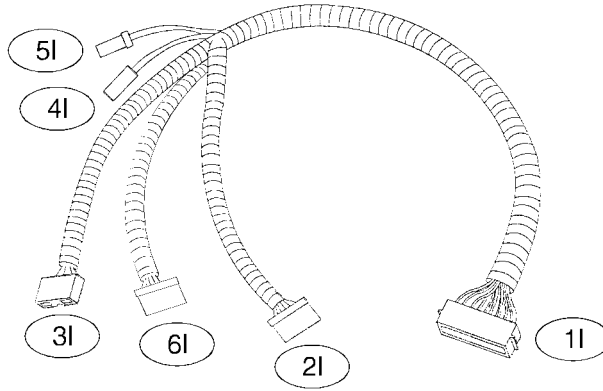

B5M0927A

GENERAL DESCRIPTION

AIRBAG SYSTEM (DIAGNOSTICS)

8. AIRBAG RESISTOR

The airbag resistor is used during diagnostics. The airbag resistor has the same resistance as the airbag module and thus provides safety when used instead of the airbag module. It also makes it possible to finish, diagnostics in less time.

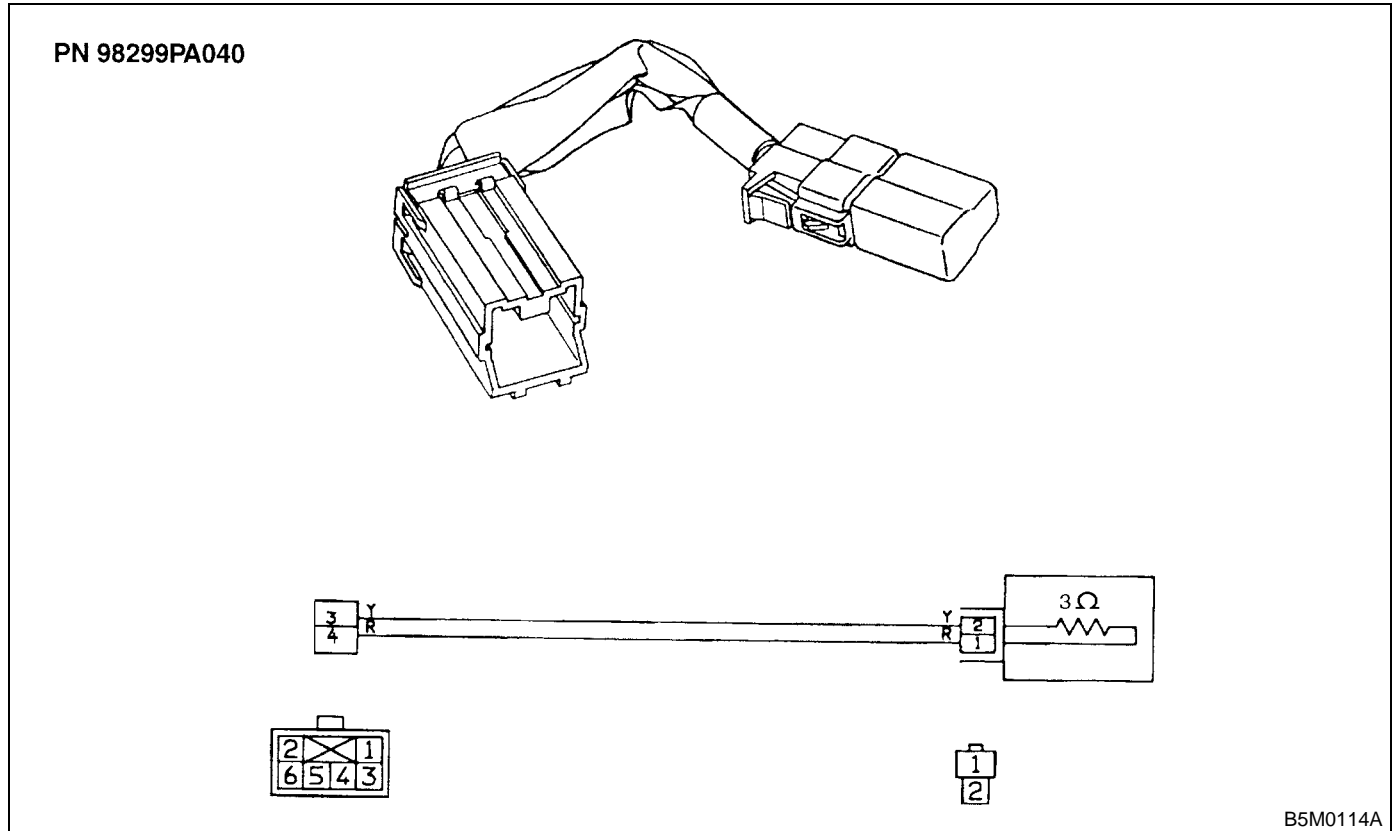

ELECTRICAL COMPONENTS LOCATION

AIRBAG SYSTEM (DIAGNOSTICS)

4. Electrical Components Location

A: LOCATION

1. LHD MODEL

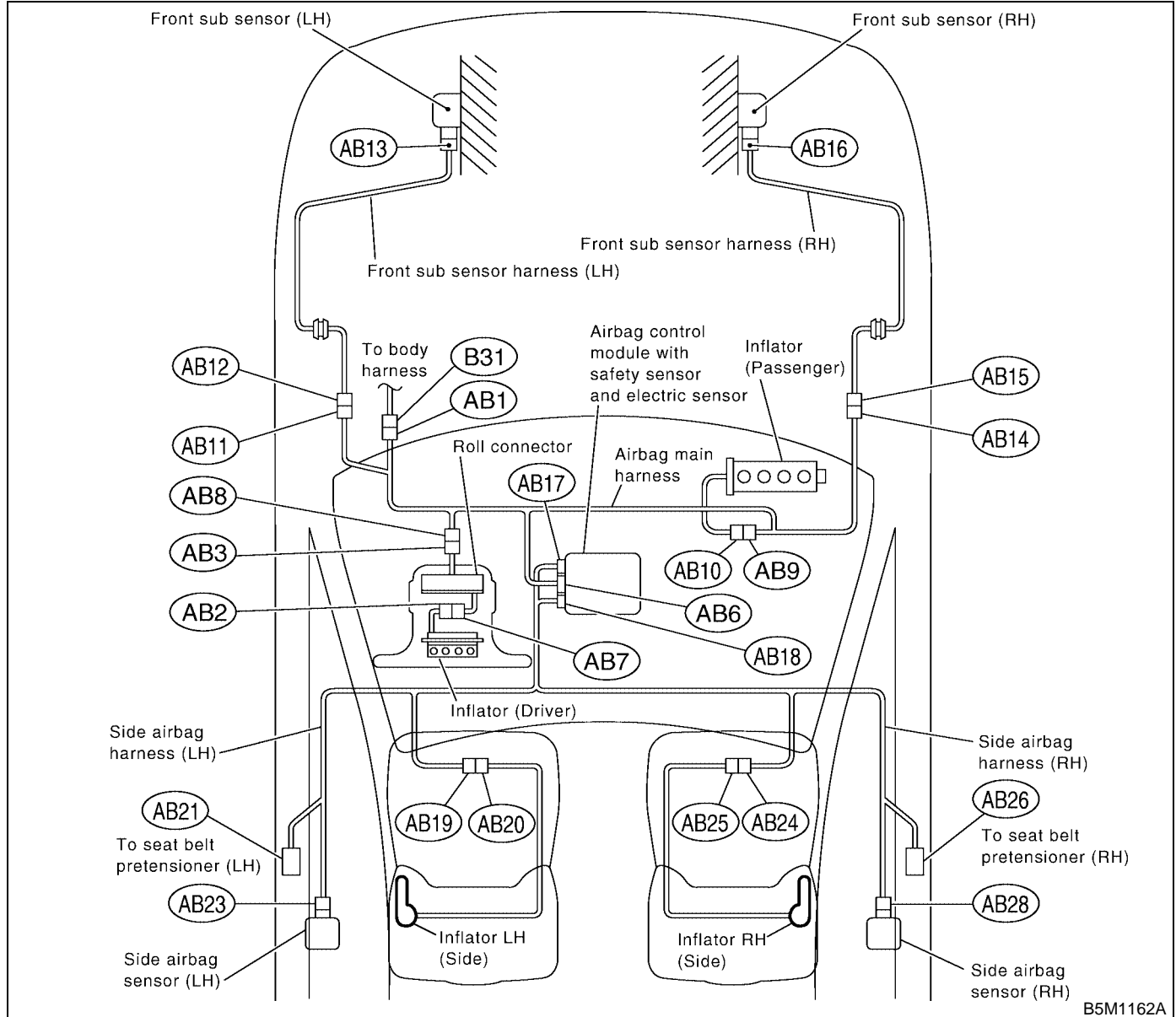

B5M1162A

Connector No.	(AB1)	(AB2)	(AB3)	(AB6)	(AB7)	(AB8)	(AB9)	(AB10)	(AB11)	(AB12)	(AB13)	(AB14)
Pole	6	2	2	28	2	2	2	2	2	2	2	2
Color	Yellow	Yellow	Yellow	Yellow	Yellow	Yellow	Yellow	Yellow	Blue	Blue	Yellow	Blue
Male/Female	Male	Male	Male	Female	Female	Female	Female	Male	Male	Female	Female	Male
Connector No.	(AB15)	(AB16)	(AB17)	(AB18)	(AB19)	(AB20)	(AB21)	(AB23)	(AB24)	(AB25)	(AB26)	(AB28)
Pole	2	2	12	12	2	2	2	4	2	2	2	4
Color	Blue	Yellow	Yellow	Yellow	Yellow	Yellow	Yellow	Yellow	Yellow	Yellow	Yellow	Yellow
Male/Female	Female	Female	Female	Female	Female	Male	Female	Female	Female	Male	Female	Female

ELECTRICAL COMPONENTS LOCATION

AIRBAG SYSTEM (DIAGNOSTICS)

2. RHD MODEL

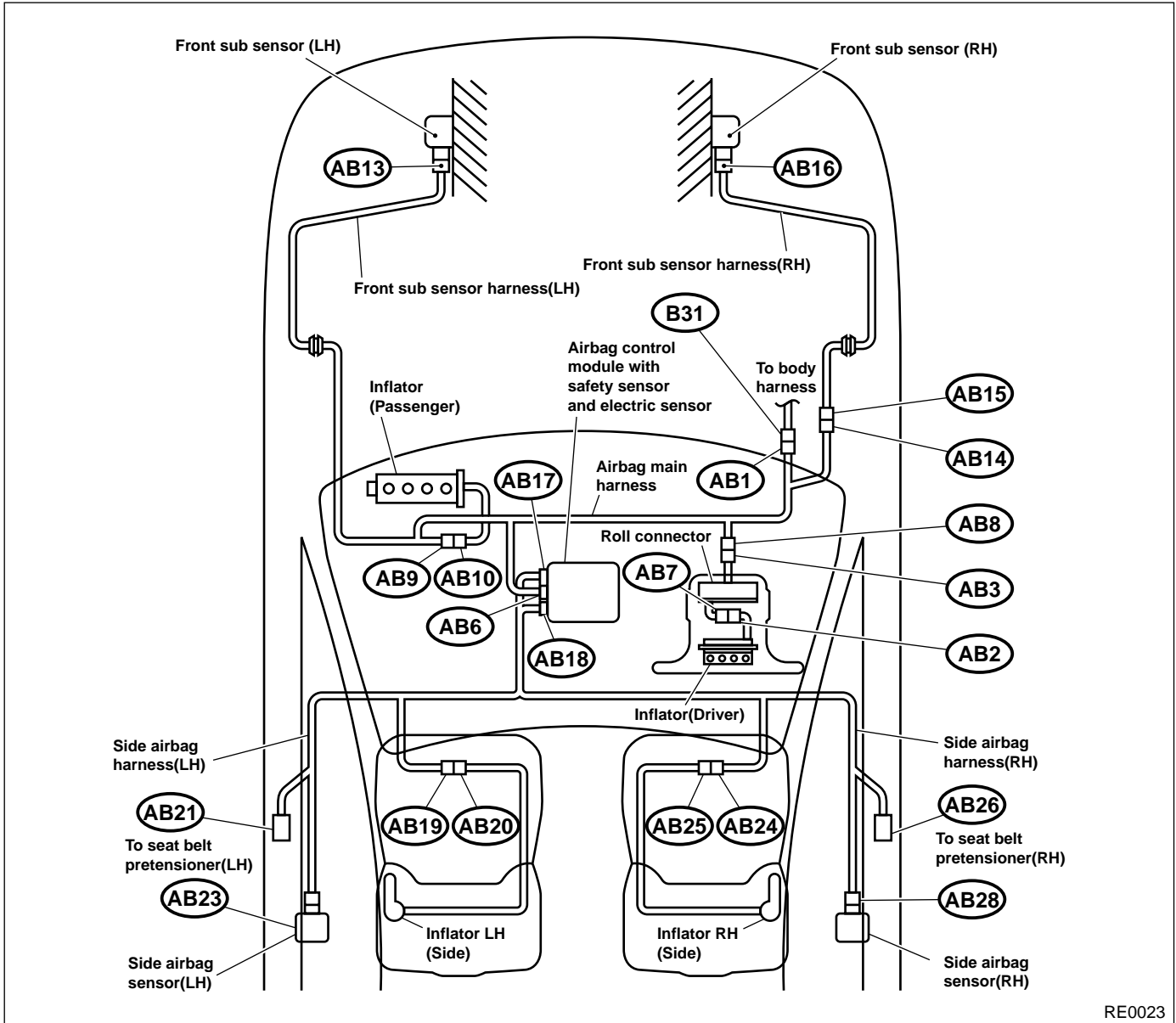

RE0023

Connector No.	(AB1)	(AB2)	(AB3)	(AB6)	(AB7)	(AB8)	(AB9)	(AB10)	(AB13)	(AB14)		
Pole	6	2	2	28	2	2	2	2	2	2		
Color	Yellow	Yellow	Yellow	Yellow	Yellow	Yellow	Yellow	Yellow	Yellow	Blue		
Male/Female	Male	Male	Male	Female	Female	Female	Female	Male	Female	Female		
Connector No.	(AB15)	(AB16)	(AB17)	(AB18)	(AB19)	(AB20)	(AB21)	(AB23)	(AB24)	(AB25)	(AB26)	(AB28)
Pole	2	2	12	12	2	2	2	4	2	2	2	4
Color	Blue	Yellow	Yellow	Yellow	Yellow	Yellow	Yellow	Yellow	Yellow	Yellow	Yellow	Yellow
Male/Female	Male	Female	Female	Female	Female	Male	Female	Female	Female	Male	Female	Female

5. A/B Control Module I/O Signal

A: SCHEMATIC

A/B CONTROL MODULE I/O SIGNAL

AIRBAG SYSTEM (DIAGNOSTICS)

1. AIRBAG LHD MODEL

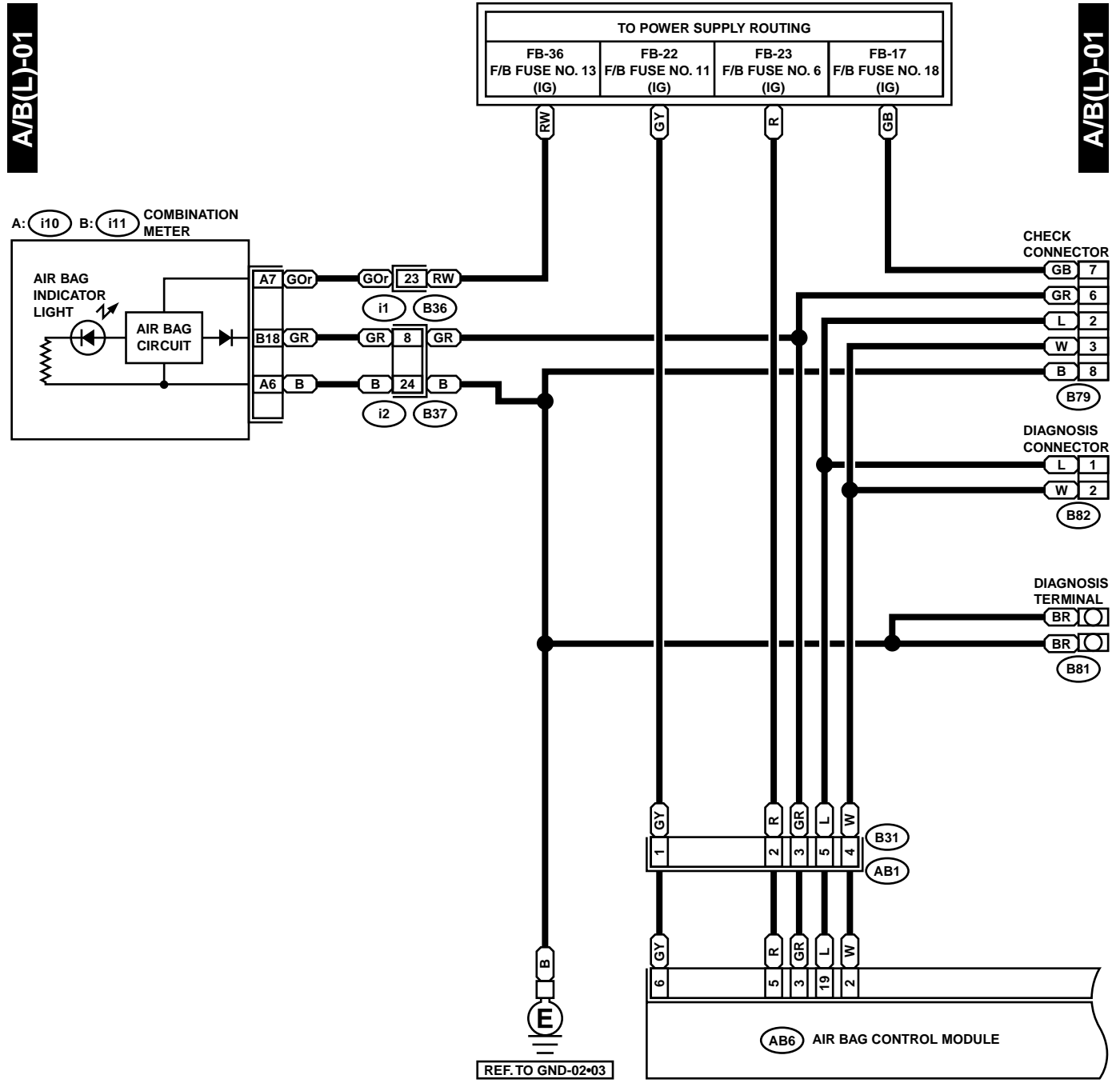

A/B(L)-01

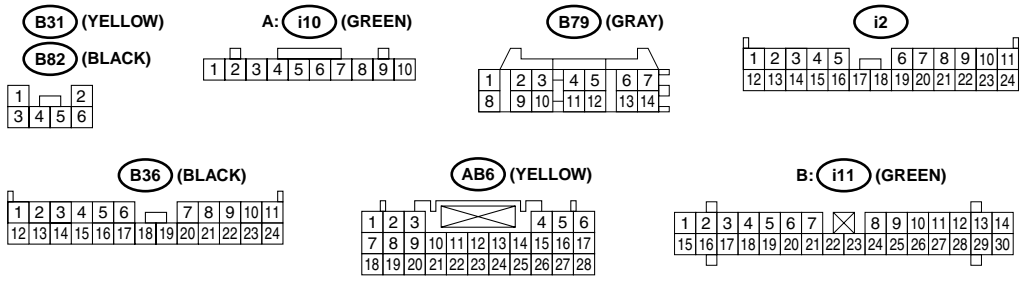

GL86-20A

A/B CONTROL MODULE I/O SIGNAL

AIRBAG SYSTEM (DIAGNOSTICS)

A/B(L)-02

A/B(L)-02

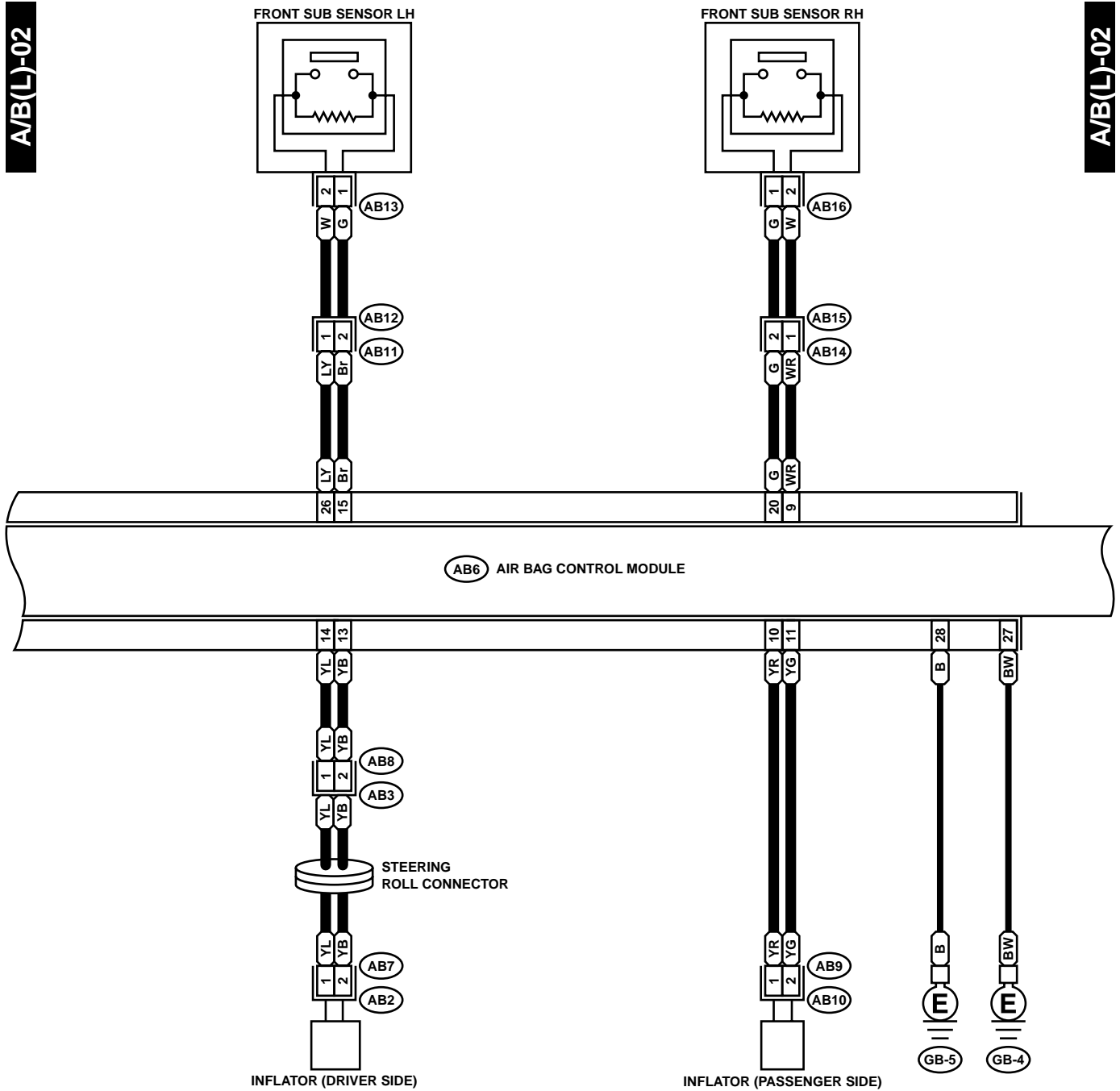

- AB7 (YELLOW)
- AB11 (YELLOW)
- AB13 (YELLOW)
- AB8 (YELLOW)
- AB14 (YELLOW)
- AB16 (YELLOW)
- AB9 (YELLOW)

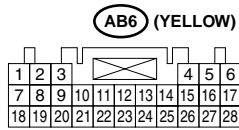
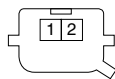

A/B CONTROL MODULE I/O SIGNAL

AIRBAG SYSTEM (DIAGNOSTICS)

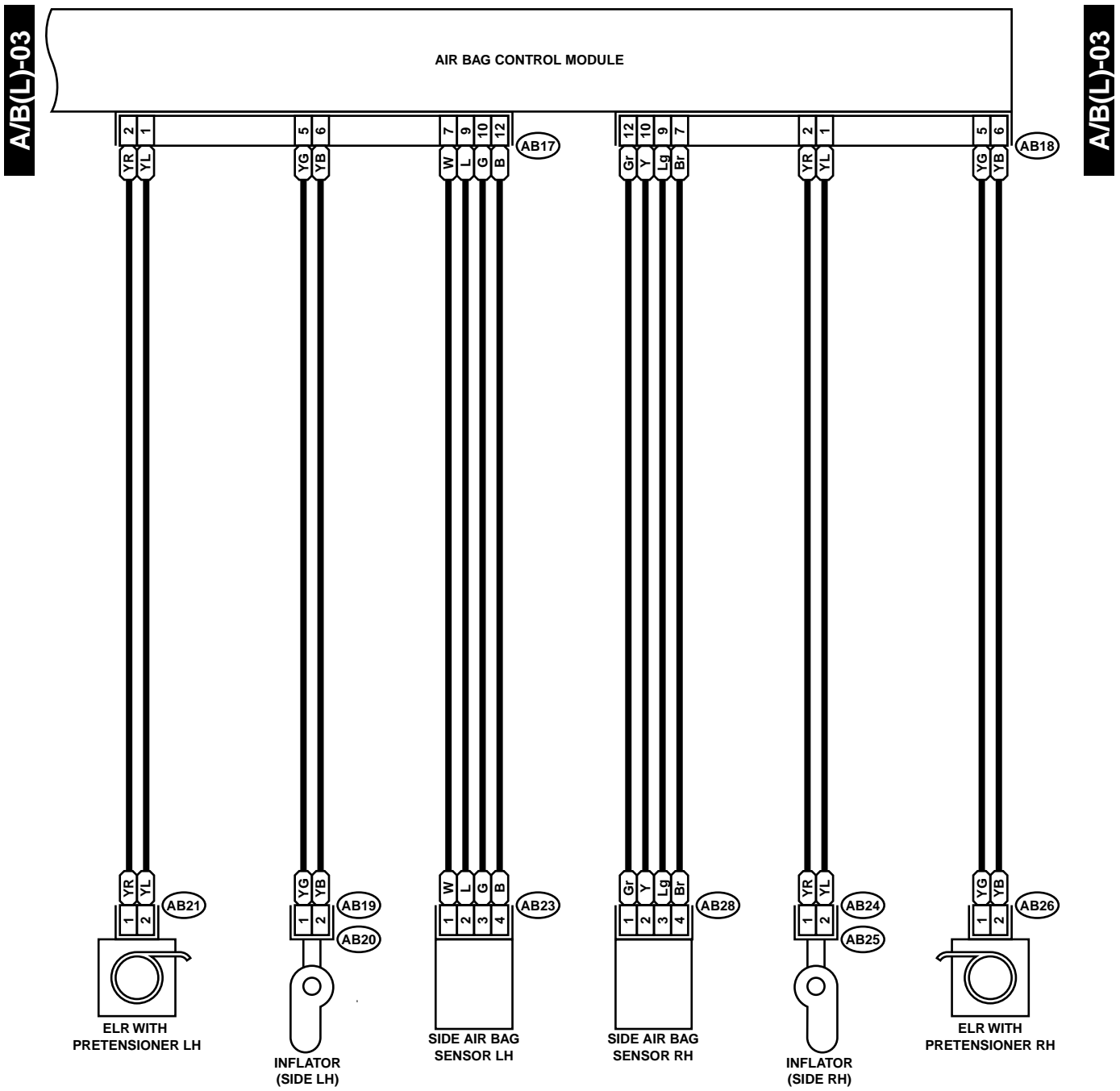

(YELLOW) AB19 (YELLOW) AB24 (YELLOW)
 (YELLOW) AB21 (YELLOW) AB26 (YELLOW)



AB23 (YELLOW)
 AB28 (YELLOW)

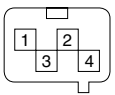

AB17 (YELLOW)

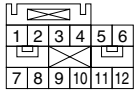

AB18 (YELLOW)

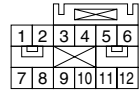

GL86-20C

A/B CONTROL MODULE I/O SIGNAL

AIRBAG SYSTEM (DIAGNOSTICS)

2. AIRBAG RHD MODEL

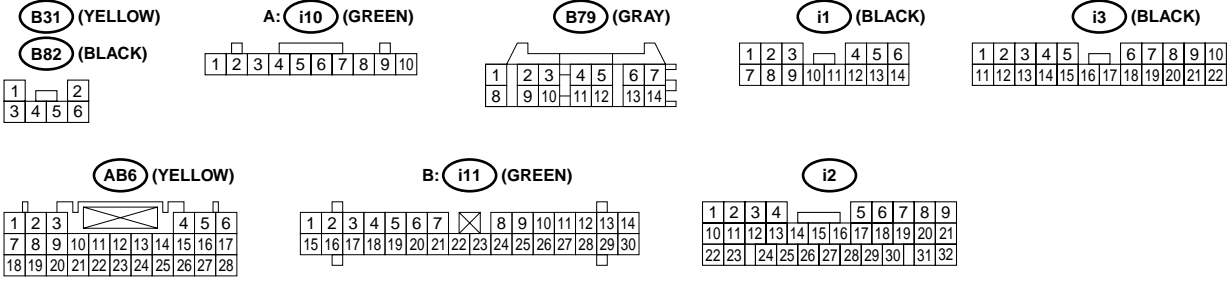
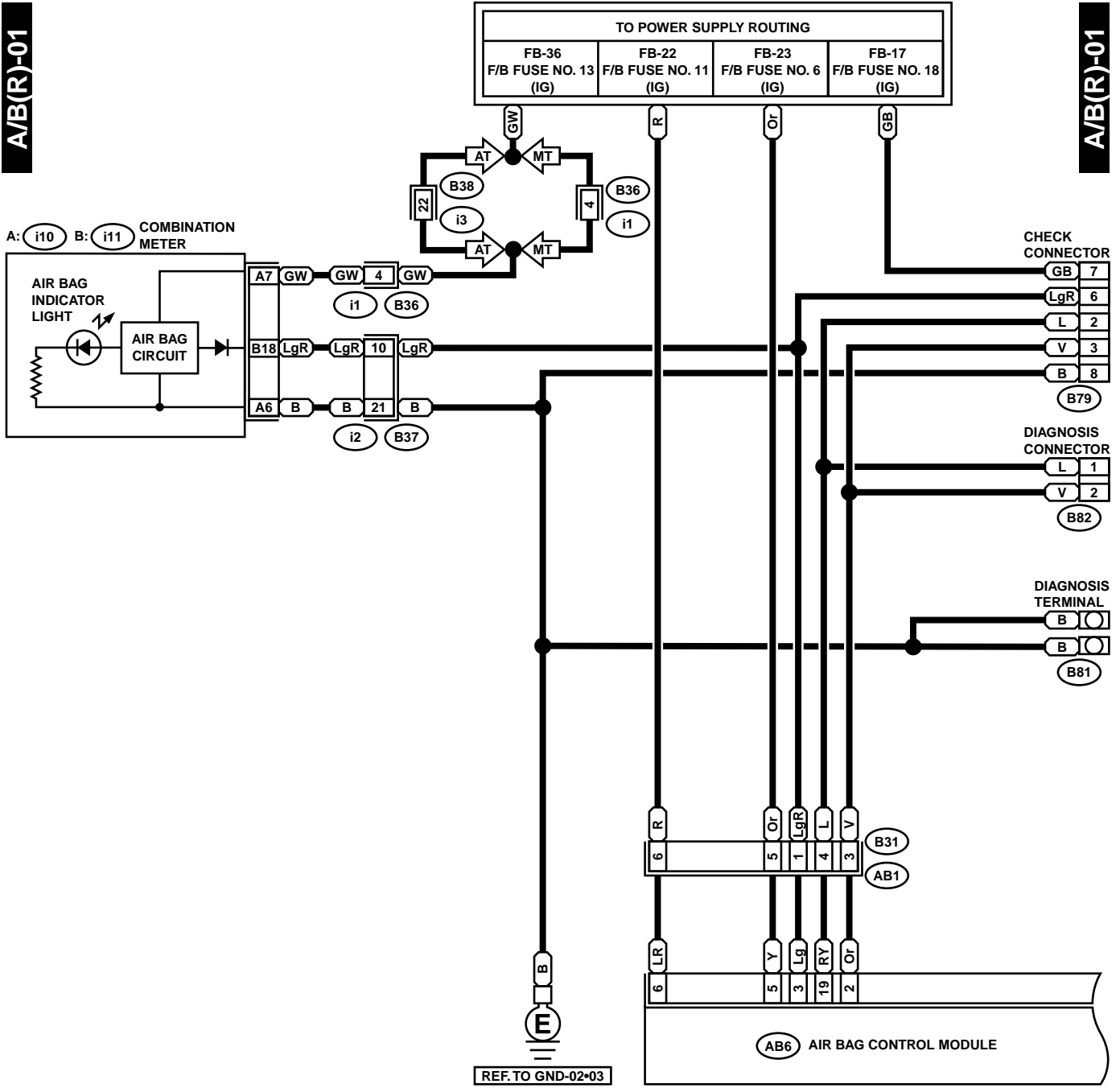

A/B CONTROL MODULE I/O SIGNAL

AIRBAG SYSTEM (DIAGNOSTICS)

A/B(R)-02

A/B(R)-02

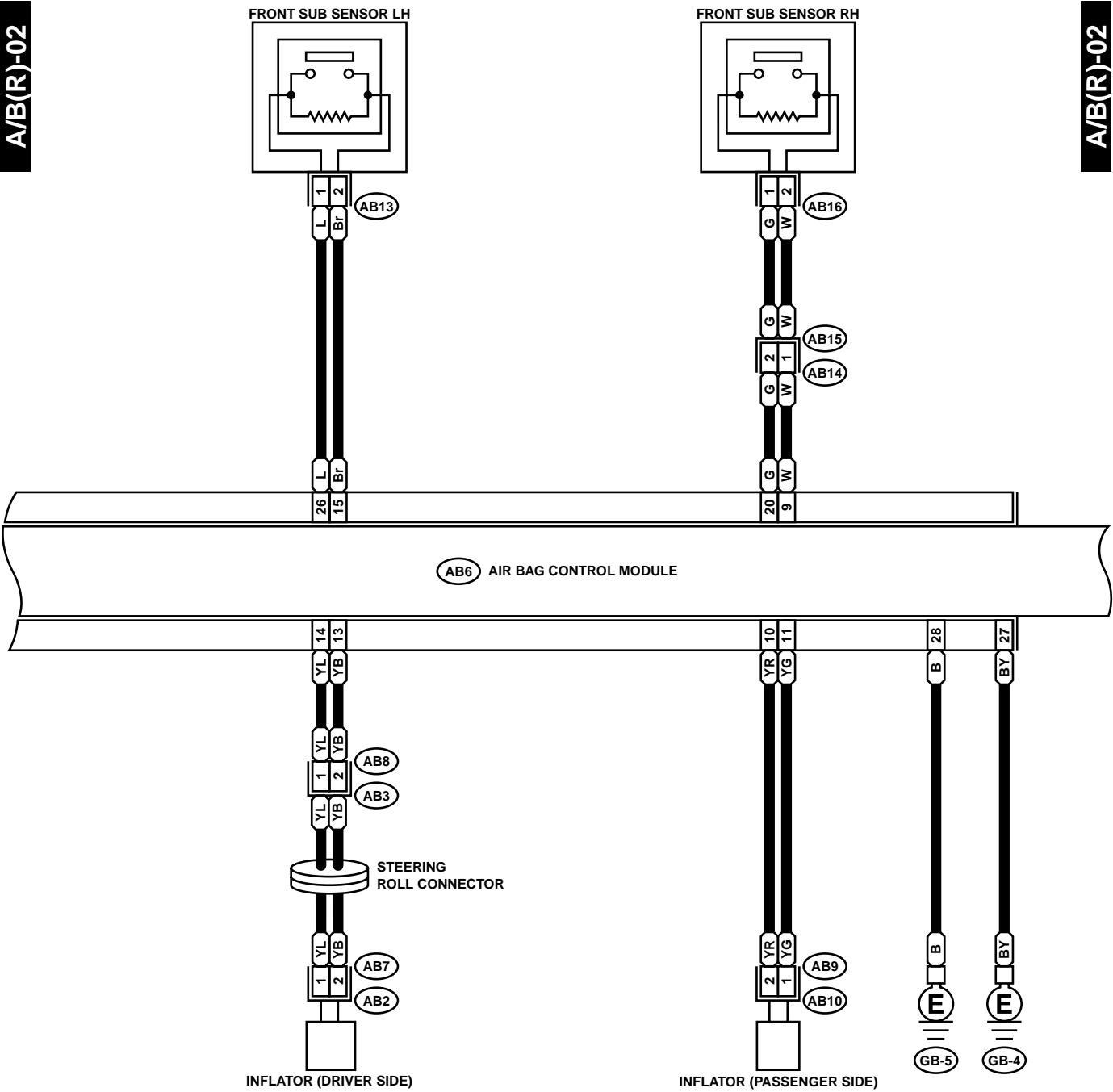

- (YELLOW) AB7
- (YELLOW) AB14
- (YELLOW) AB13
- (YELLOW) AB8
- (YELLOW) AB9
- (YELLOW) AB16

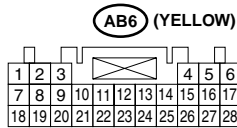
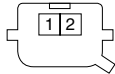

A/B CONTROL MODULE I/O SIGNAL

AIRBAG SYSTEM (DIAGNOSTICS)

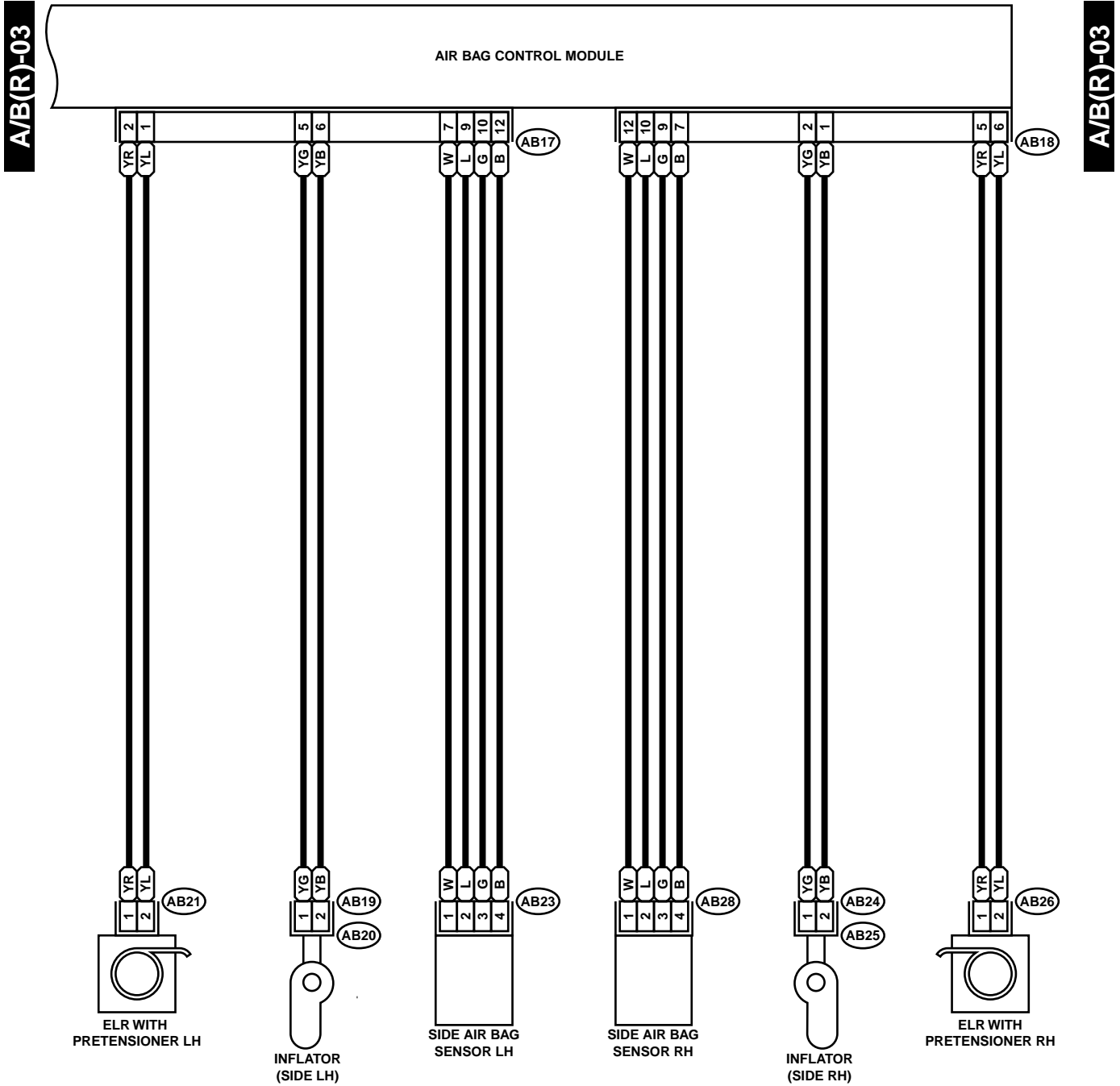

(YELLOW) AB19 (YELLOW)
 (YELLOW) AB21 (YELLOW)



AB23 (YELLOW)
 AB28 (YELLOW)

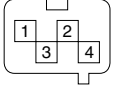

AB17 (YELLOW)

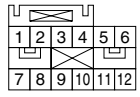

AB18 (YELLOW)

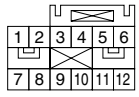

AIRBAG CONNECTOR

AIRBAG SYSTEM (DIAGNOSTICS)

6. Airbag Connector

A: OPERATION

1. POWER SUPPLY

• How to disconnect:

- 1) Move slide lock (A) in the direction of the arrow.
- 2) Pull female connector in the direction of the arrow with slide lock (A) moved.

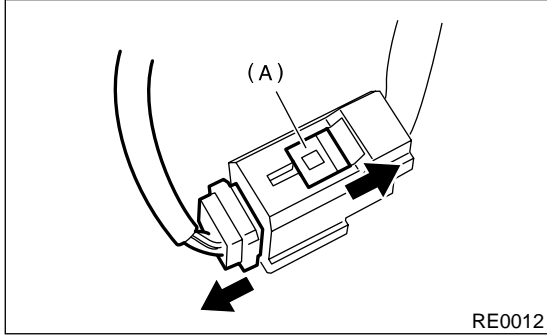

CAUTION:
When pulling, be sure to hold onto the connector and not the wire.

• How to connect:

Holding connector (A), and push it in carefully until a connecting sound is heard.

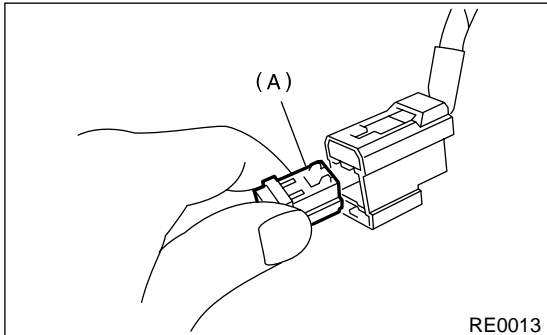

CAUTION:
Be sure to insert the connector in until it locks. Then pull on it gently to make sure that it is locked.

2. DRIVER'S AIRBAG, PASSENGER'S AIRBAG, AND SIDE AIRBAG

• How to disconnect:

- 1) Push lock arm (A).

- 2) With lock arm (A) pushed in, move slide lock (B) in the direction of the arrow.

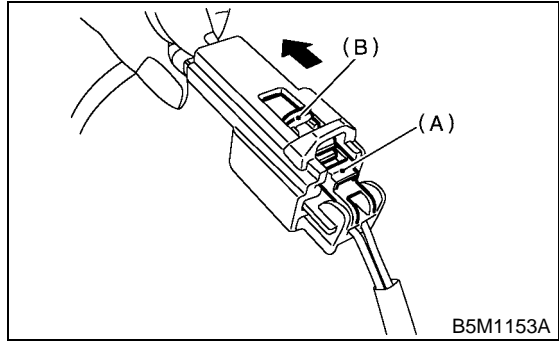

- 3) With slide lock (B) pulled, remove lock arm (A) to its original position, and then pull in the direction of the arrow and separate the connector.

CAUTION:
When pulling, be sure to hold onto the connector and not the wire.

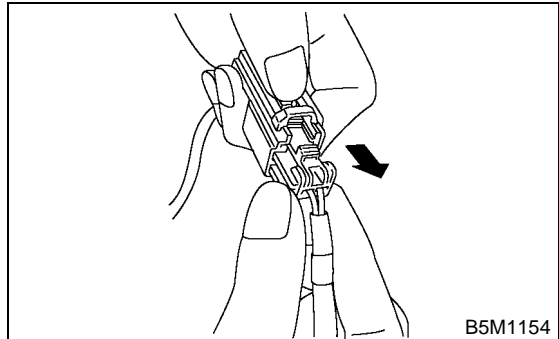

• How to connect:

Holding the connector, and push it in carefully until a connecting sound is heard.

CAUTION:
Be sure to insert the connector in until it locks. Then pull on it gently to make sure that it is locked.

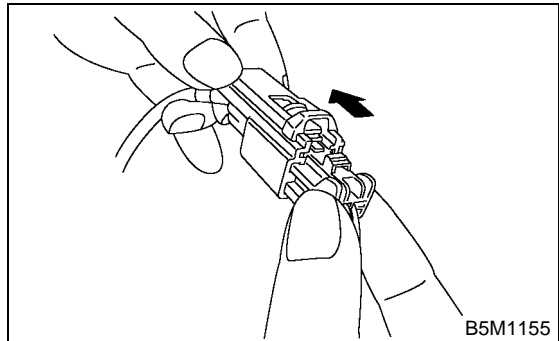

3. FRONT SUB-SENSOR, SIDE AIRBAG SENSOR

• How to disconnect:

- 1) Holding outer part (A), pull it in the direction of the arrow.

CAUTION:

When pulling, be sure to hold onto the connector and not the wire.

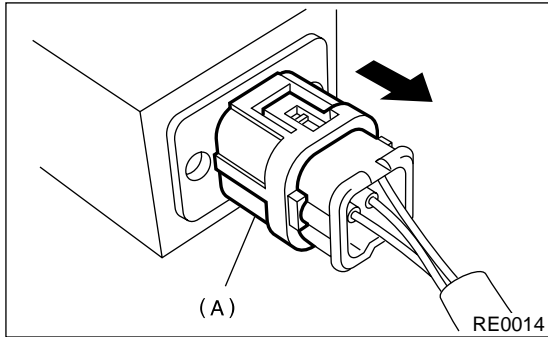

• **How to connect:**

Holding the connector, and push it in carefully until a connecting sound is heard.

CAUTION:

- Outer (A) moves back, and so do not put your hand on the outer part.
- Be sure to insert the connector in until it locks. Then pull on it gently to make sure that it is locked.

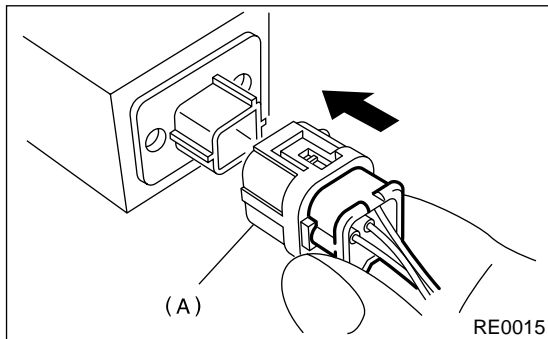

4. PRETENSIONER

• **How to disconnect:**

- 1) Move slide lock (A) in the direction of the arrow.
- 2) Pull the connector (B) in the direction of the arrow with slide lock (A) moved.

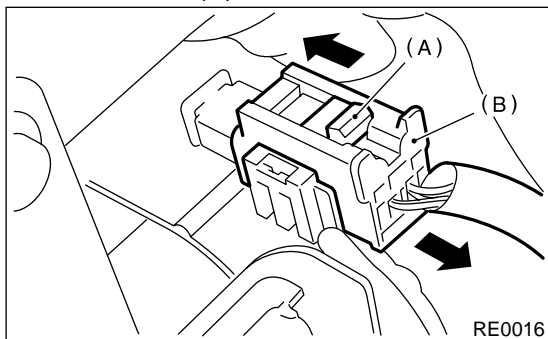

CAUTION:

When pulling, be sure to hold onto the connector and not the wire.

• **How to connect:**

Holding connector (A), and push it in carefully until a connecting sound is heard.

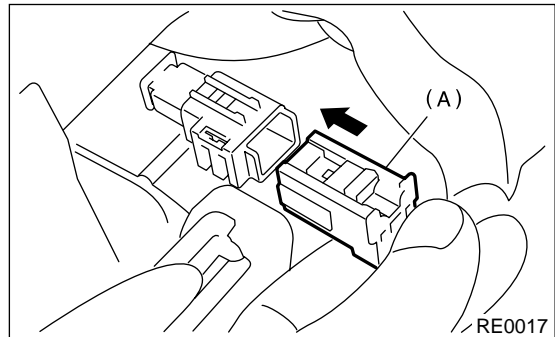

CAUTION:

Be sure to insert the connector in until it locks. Then pull on it gently to make sure that it is locked.

AIRBAG WARNING LIGHT ILLUMINATION PATTERN

AIRBAG SYSTEM (DIAGNOSTICS)

7. Airbag Warning Light Illumination Pattern

A: INSPECTION

Keep the ignition switch ON, and confirm that the airbag warning light remains off approximately 6 seconds after being turned on.

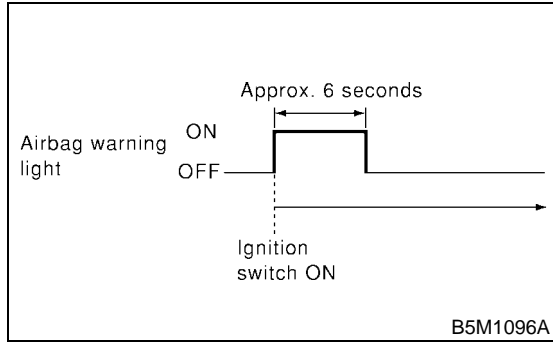

READ DIAGNOSTIC TROUBLE CODE

AIRBAG SYSTEM (DIAGNOSTICS)

8. Read Diagnostic Trouble Code

A: OPERATION

- 1) Turn the ignition switch ON.
- 2) Connect the diagnosis terminal to diagnosis connector terminal No. 1 in the driver's seat lower cover area.

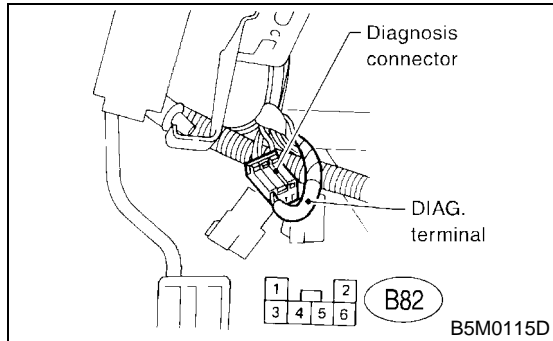

3) Read trouble code by identifying the way the air bag warning light flashes.

The airbag warning light flashes a code corresponding to the faulty parts.

The long segment (1.2 sec on) indicates a "ten", and the short segment (0.3 sec on) indicates a "one".

NOTE:

- "List of Diagnostic Trouble Code" <Ref. to AB-38, List of Diagnostic Trouble Code.>
- "Airbag Warning Light Failure" <Ref. to AB-33, Airbag Warning Light Failure.>

Example:

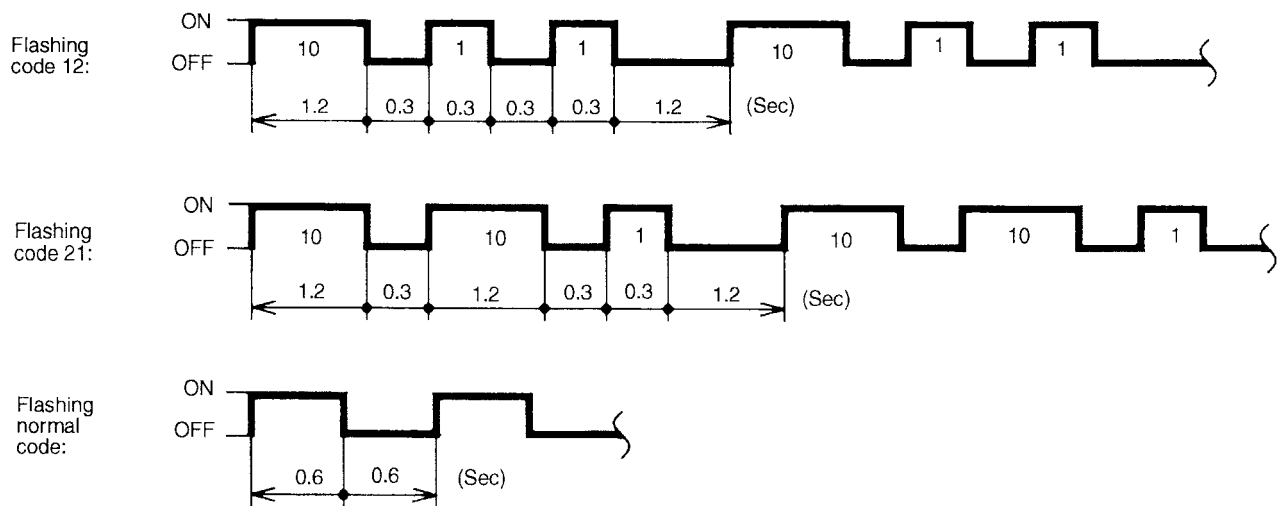

B5M0117A

- 4) Turn the ignition switch OFF, and disconnect the diagnosis terminal from the diagnosis connector terminal No 1.
- 5) Wind tape around the diagnosis terminal and return it to its original position.

9. Inspection Mode

A: OPERATION

Recreate the circumstance by referring to the conditions described in the checklist.

10. Clear Memory Mode

A: OPERATION

- 1) Turn the ignition switch ON.
- 2) Connect the diagnosis terminal (DIAG, terminal "A") to diagnosis connector terminal No. 1 in the driver's seat lower cover area.

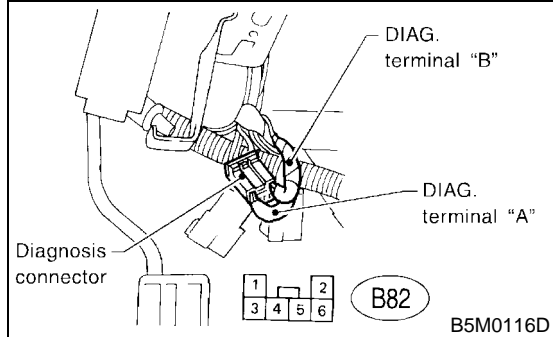

- 3) While the warning light flashes, connect another diagnosis terminal (DIAG, terminal "B") to diagnosis connector terminal No.2.
- 4) Once the memory is erased, the warning light returns to the normal flash rate (0.6 sec on). The failure to recover the normal flash rate indicates that trouble parts still remain. Having repaired such parts, erase the memory again and confirm that the normal flash rate has returned.
- 5) When the memory has been cleared, disconnect the diagnosis terminal from the diagnosis connector.
- 6) Wind tape around the diagnosis terminal and return it to its original position.

CLEAR MEMORY MODE

AIRBAG SYSTEM (DIAGNOSTICS)

11. Airbag Warning Light Failure

A: AIRBAG WARNING LIGHT REMAINS ON.

DIAGNOSIS:

- Airbag warning light is faulty.
- Airbag control module to airbag warning light circuit is shorted or open.
- Grounding circuit is faulty.
- Airbag control module is faulty.
- (AB1) and (B31) are not connected properly.
- (AB6) is not connected properly to airbag control module.

CAUTION:

- Before diagnosing the airbag system, be sure to turn the ignition switch OFF, disconnect the ground cable from the battery, and wait more than 20 seconds before starting to work.
- Before replacing the airbag module, roll connector, control module, and sensor, reconnect each part and confirm that the warning light operates properly.
- When inspecting the airbag main harness, disconnect the airbag module connector of the driver and passenger seats for safety reasons.

AIRBAG WARNING LIGHT FAILURE

AIRBAG SYSTEM (DIAGNOSTICS)

WIRING DIAGRAM:

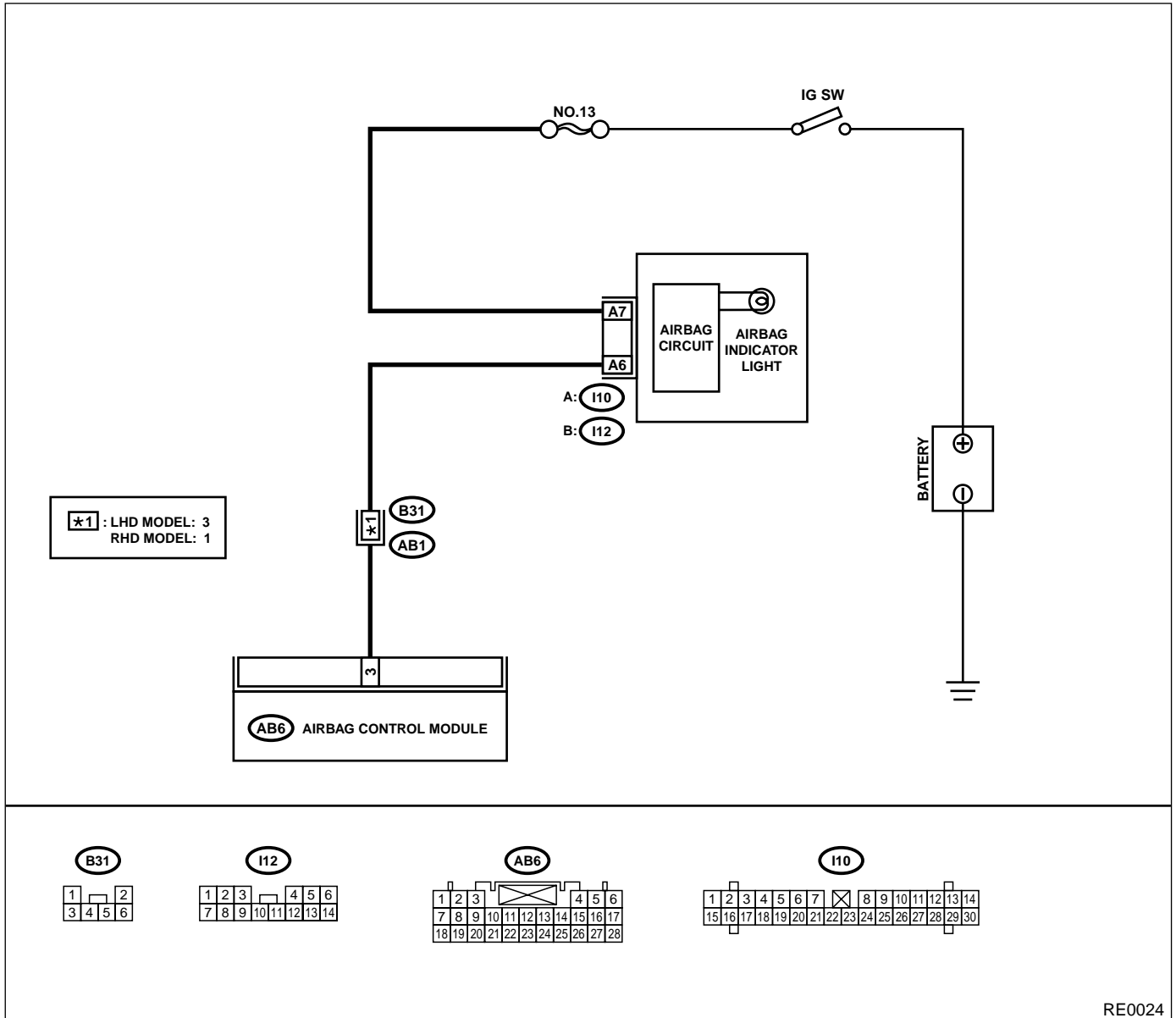

	Step	Check	Yes	No
1	<p>CHECK POOR CONTACT IN CONNECTORS (AB1) AND (B31).</p> <p>1) Turn the ignition switch OFF, disconnect the battery ground cable, and wait more than 20 seconds.</p> <p>2) Remove side sill cover. (Driver's side)</p> <p>3) Confirm that firm contact is secured between connectors (AB1) and (B31).</p>	<p>Is the poor contact in connectors (AB1) and (B31)?</p>	<p>Repair the body harness or replace the body harness with airbag main harness.</p>	<p>Go to step 2.</p>

AIRBAG WARNING LIGHT FAILURE

AIRBAG SYSTEM (DIAGNOSTICS)

Step	Check	Yes	No
2 CHECK AIRBAG WARNING LIGHT. 1) Turn the ignition switch OFF, disconnect the battery ground cable, and wait more than 20 seconds. 2) Connect the connector (1M) in test harness M to the body harness connector (B31). 3) Connect the battery ground cable and turn the ignition switch ON. 4) Connect two connectors, (3M) and (4M) in test harness M.	Is the airbag warning light turned off?	Go to step 4.	Go to step 3.
3 CHECK BODY HARNESS. Check the body harness. NOTE: After problem has been eliminated, disconnect connectors (3M) and (4M).	Is there anything unusual to body harness?	Repair the body harness.	Replace combination meter printed circuit. <Ref. to IDI-19, Combination Meter Assembly.>
4 CHECK POOR CONTACT. Confirm that firm contact is secured between the airbag control module and the connector (AB6). <Ref. to AB-16, Airbag Control Module.>	Is there poor contact in connector (AB6)?	Replace the body harness with airbag main harness or Replace the airbag control module. <Ref. to AB-16, Airbag Control Module.>	Go to step 5.
5 CHECK AIRBAG MAIN HARNESS. 1) Turn the ignition switch OFF, disconnect the battery ground cable, and wait more than 20 seconds. 2) Connect the connector (AB1) to (B31). 3) Disconnect connectors (AB3) and (AB8). 4) Remove glove box and disconnect connectors (AB10) and (AB9). 5) Disconnect the connector (AB6) from the airbag control module, and connect the connector (1I) in test harness I or I2. <Ref. to AB-16, Airbag Control Module.> 6) Connect the battery ground cable and turn the ignition switch ON. 7) Connect connectors (4I) and (5I) in test harness I or I2. NOTE: After problem has been eliminated, disconnect connectors (4I) and (5I).	Is the airbag warning light turned off?	Go to step 6.	Replace the body harness with airbag main harness.
6 CHECK GROUNDING CIRCUIT. 1) Turn the ignition switch OFF, disconnect the battery ground cable, and wait more than 20 seconds. 2) Disconnect the connector (AB6) from the airbag control module. 3) Connect the connector (1I) in test harness I or I2 to body harness connector (AB6). 4) Measure the resistance between connector (2I) in test harness I or I2 and the chassis ground. Connector & terminal (2I) No. 9 — Chassis ground: (2I) No. 10 — Chassis ground:	Is the resistance less than 10 Ω ?	Replace the airbag control module. <Ref. to AB-16, Airbag Control Module.>	Repair body-grounding circuit.

AIRBAG WARNING LIGHT FAILURE

AIRBAG SYSTEM (DIAGNOSTICS)

B: AIRBAG WARNING LIGHT REMAINS OFF.

DIAGNOSIS:

- Fuse No. 13 (in fuse box) is blown.
- Body harness circuit is open.
- Airbag warning light is faulty.
- Airbag main harness is faulty.
- Airbag control module is faulty.

CAUTION:

- Before diagnosing the airbag system, be sure to turn the ignition switch OFF, disconnect the ground cable from the battery, and wait more than 20 seconds before starting to work.
- Before replacing the airbag module, roll connector, control module, and sensor, reconnect each part and confirm that the warning light operates properly.
- When inspecting the airbag main harness, disconnect the airbag module connector of the driver and passenger seats for safety reasons.

WIRING DIAGRAM:

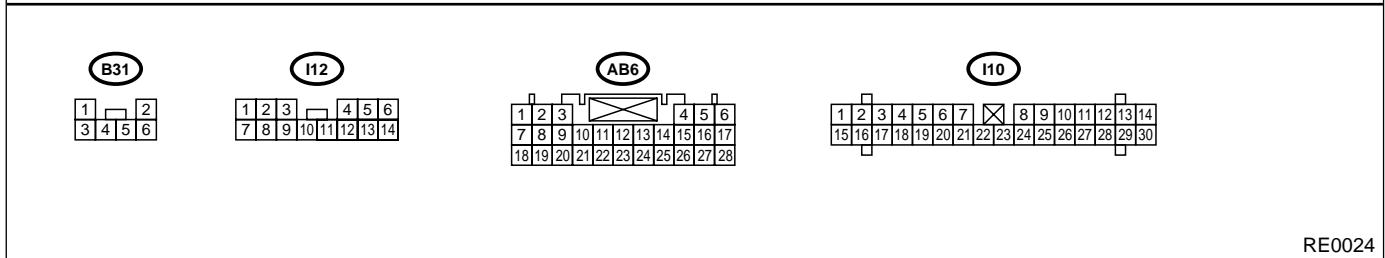
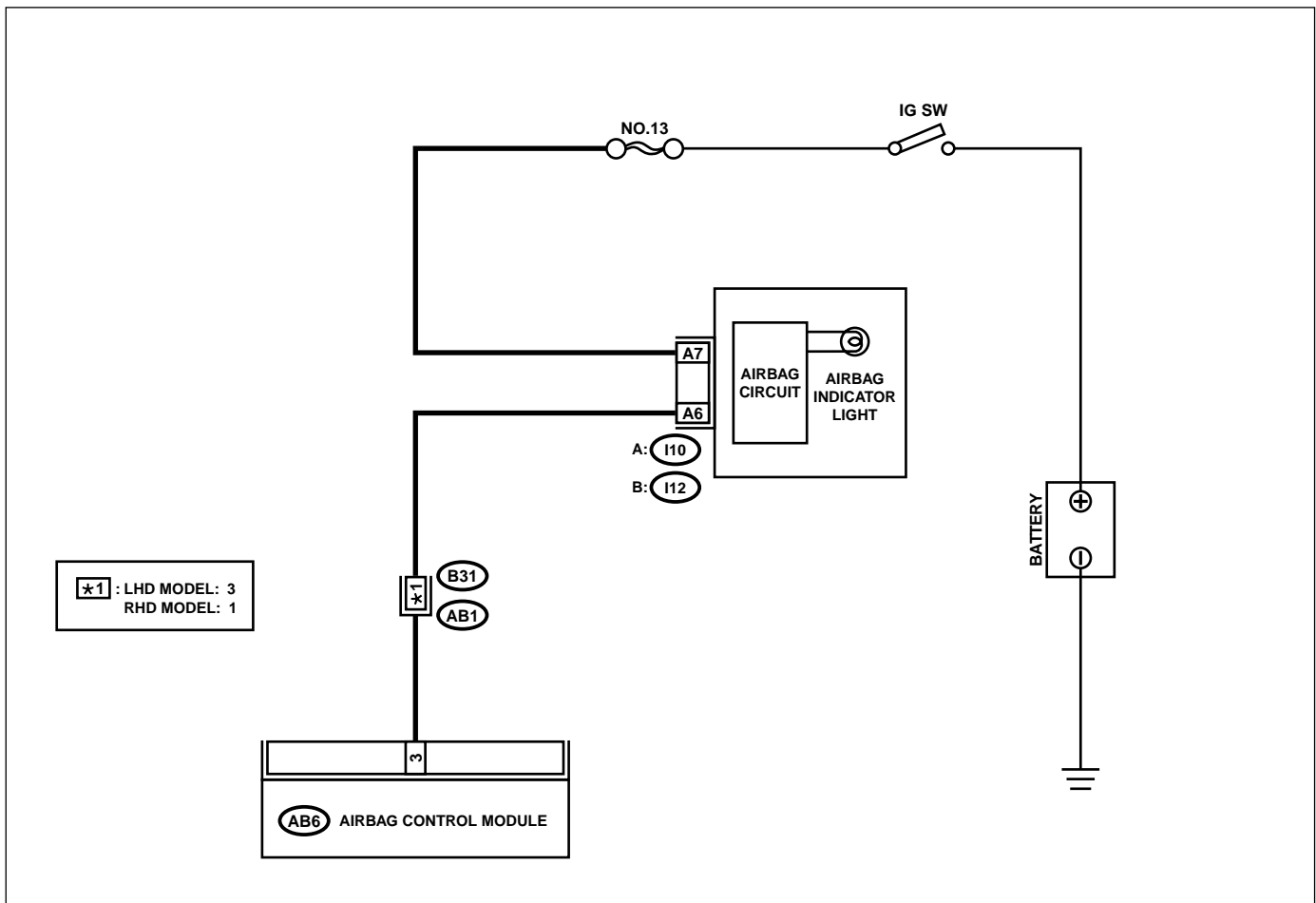

RE0024

AIRBAG WARNING LIGHT FAILURE

AIRBAG SYSTEM (DIAGNOSTICS)

Step	Check	Yes	No
1 CHECK COMBINATION METER. Turn the ignition switch ON, and confirm that warning lights equipped in the combination meter are turned on.	Do warning lights not for the airbag turn on?	Go to step 2 .	Repair combination meter power supply. <Ref. to IDI-4, Combination Meter System.>
2 CHECK FUSE NO. 13 (IN MAIN FUSE BOX). Remove fuse No. 13 and perform visual inspection.	Is fuse No. 13 (in main fuse box) blown?	Replace fuse No. 13. If fuse No. 13 blows again, go to step 3.	Go to step 3 .
3 CHECK AIRBAG WARNING LIGHT CIRCUIT (IN COMBINATION METER). 1) Turn the ignition switch OFF, disconnect the battery ground cable, and wait more than 20 seconds. 2) Disconnect the connector (AB1) from (B31). 3) Connect the battery ground cable and turn the ignition switch ON.	Is the airbag warning light turned on?	Go to step 4 .	Replace airbag warning light bulb or combination meter printed circuit. <Ref. to IDI-19, Combination Meter Assembly.>
4 CHECK AIRBAG MAIN HARNESS. 1) Turn the ignition switch OFF, disconnect the battery ground cable, and wait more than 20 seconds. 2) Connect the connector (AB1) to (B31). 3) Disconnect the connector (AB6) from the airbag control module. <Ref. to AB-16, Airbag Control Module.> 4) Connect the battery ground cable and turn the ignition switch ON.	Is the airbag warning light turned on?	Replace the airbag control module. <Ref. to AB-16, Airbag Control Module.>	Replace the body harness with airbag main harness.

LIST OF DIAGNOSTIC TROUBLE CODE

AIRBAG SYSTEM (DIAGNOSTICS)

12. List of Diagnostic Trouble Code

A: LIST

Trouble code/ Contents of troubles	Memory function	Contents of diagnosis	Index No.
11	Provided.	<ul style="list-style-type: none"> • Airbag main harness circuit is open, shorted or shorted to ground. • Airbag module harness (driver) circuit is open, shorted or shorted to ground. • Roll connector circuit is open, shorted or shorted to ground. • Airbag control module is faulty. • Driver's airbag module is faulty. 	<Ref. to AB-42, TROUBLE CODE 11, Diagnostic Chart with Trouble Code.>
12	Provided.	<ul style="list-style-type: none"> • Airbag main harness circuit is open, shorted or shorted to ground. • Airbag module harness (passenger) circuit is open, shorted or shorted to ground. • Airbag control module is faulty. • Passenger's airbag module is faulty. 	<Ref. to AB-44, TROUBLE CODE 12, Diagnostic Chart with Trouble Code.>
15	Provided.	<ul style="list-style-type: none"> • Airbag main harness circuit (driver) is shorted to power supply. • Airbag module harness (driver) is shorted to power supply. • Roll connector is shorted to power supply. • Airbag control module is faulty. • Driver's airbag module is faulty. 	<Ref. to AB-46, TROUBLE CODE 15, Diagnostic Chart with Trouble Code.>
16	Provided.	<ul style="list-style-type: none"> • Airbag main harness circuit (passenger) is shorted to power supply. • Airbag module harness (passenger) is shorted to power supply. • Airbag control module is faulty. • Passenger's airbag module is faulty. 	<Ref. to AB-48, TROUBLE CODE 16, Diagnostic Chart with Trouble Code.>
21	Provided.	Airbag control module is faulty.	<Ref. to AB-49, TROUBLE CODE 21, Diagnostic Chart with Trouble Code.>
22	Provided.	Front airbag module and seat belt pretensioner (LH/RH) are inflated.	<Ref. to AB-50, TROUBLE CODE 22, Diagnostic Chart with Trouble Code.>
23	Not provided.	(AB6), (AB17) and (AB18) are not connected properly to airbag control module.	<Ref. to AB-51, TROUBLE CODE 23, Diagnostic Chart with Trouble Code.>
24	Not provided.	<ul style="list-style-type: none"> • Airbag control module is faulty. • Airbag main harness circuit is open. • Fuse No. 11 (in joint box) is blown. • Body harness circuit is open. 	<Ref. to AB-52, TROUBLE CODE 24, Diagnostic Chart with Trouble Code.>
25	Provided.	<ul style="list-style-type: none"> • Airbag control module is faulty. • Airbag main harness circuit is open. • Fuse No. 6 (in joint box) is blown. • Body harness circuit is open. 	<Ref. to AB-54, TROUBLE CODE 25, Diagnostic Chart with Trouble Code.>
31	Provided.	<ul style="list-style-type: none"> • Front sub-sensor harness (RH) circuit is shorted. • Front sub-sensor harness (RH) circuit is open. • Front sub-sensor (RH) is faulty. • Airbag control module is faulty. 	<Ref. to AB-56, TROUBLE CODE 31, Diagnostic Chart with Trouble Code.>

LIST OF DIAGNOSTIC TROUBLE CODE

AIRBAG SYSTEM (DIAGNOSTICS)

Trouble code/ Contents of troubles	Memory func- tion	Contents of diagnosis	Index No.
32	Provided.	<ul style="list-style-type: none"> • Front sub-sensor harness (LH) circuit is shorted. • Front sub-sensor harness (LH) circuit is open. • Front sub-sensor (LH) is faulty. • Airbag control module is faulty. 	<Ref. to AB-60, TROUBLE CODE 32, Diagnostic Chart with Trouble Code.>
41	Provided.	<ul style="list-style-type: none"> • Side airbag harness (RH) is faulty. • Side airbag module (RH) is faulty. • Airbag control module is faulty. 	<Ref. to AB-64, TROUBLE CODE 41, Diagnostic Chart with Trouble Code.>
42	Provided.	<ul style="list-style-type: none"> • Side airbag harness (LH) is faulty. • Side airbag module (LH) is faulty. • Airbag control module is faulty. 	<Ref. to AB-66, TROUBLE CODE 42, Diagnostic Chart with Trouble Code.>
45	Provided.	<ul style="list-style-type: none"> • Side airbag harness (RH) is shorted to power supply. • Airbag control module is faulty. 	<Ref. to AB-68, TROUBLE CODE 45, Diagnostic Chart with Trouble Code.>
46	Provided.	<ul style="list-style-type: none"> • Side airbag harness (LH) is shorted to power supply. • Airbag control module is faulty. 	<Ref. to AB-70, TROUBLE CODE 46, Diagnostic Chart with Trouble Code.>
51	Provided.	<ul style="list-style-type: none"> • Side airbag sensor (RH) is faulty. • Side airbag harness (RH) is faulty. • Airbag control module is faulty. 	<Ref. to AB-72, TROUBLE CODE 51, Diagnostic Chart with Trouble Code.>
52	Provided.	<ul style="list-style-type: none"> • Side airbag sensor (LH) is faulty. • Side airbag harness (LH) is faulty. • Airbag control module is faulty. 	<Ref. to AB-74, TROUBLE CODE 52, Diagnostic Chart with Trouble Code.>
53	Provided.	Side airbag sensor (RH) is faulty.	<Ref. to AB-75, TROUBLE CODE 53, Diagnostic Chart with Trouble Code.>
54	Provided.	Side airbag sensor (LH) is faulty.	<Ref. to AB-75, TROUBLE CODE 54, Diagnostic Chart with Trouble Code.>
55	Provided.	Side airbag module is inflated.	<Ref. to AB-75, TROUBLE CODE 55, Diagnostic Chart with Trouble Code.>
61	Provided.	<ul style="list-style-type: none"> • Seat belt pretensioner (RH) circuit is open, shorted or shorted to ground. • Airbag control module is faulty. • Pretensioner is faulty. • Pretensioner harness is faulty. 	<Ref. to AB-76, TROUBLE CODE 61, Diagnostic Chart with Trouble Code.>
62	Provided.	<ul style="list-style-type: none"> • Seat belt pretensioner (LH) circuit is open, shorted or shorted to ground. • Airbag control module is faulty. • Pretensioner is faulty. • Pretensioner harness is faulty. 	<Ref. to AB-78, Trouble Code 62, Diagnostic Chart with Trouble Code.>

LIST OF DIAGNOSTIC TROUBLE CODE

AIRBAG SYSTEM (DIAGNOSTICS)

Trouble code/ Contents of troubles	Memory func- tion	Contents of diagnosis	Index No.
65	Provided.	<ul style="list-style-type: none">• Seat belt pretensioner (RH) circuit is shorted to power supply.• Pretensioner is faulty.• Pretensioner harness is faulty.• Airbag control module is faulty.	<Ref. to AB-80, TROUBLE CODE 65, Diagnostic Chart with Trouble Code.>
66	Provided.	<ul style="list-style-type: none">• Seat belt pretensioner (LH) circuit is shorted to power supply.• Pretensioner is faulty.• Pretensioner harness is faulty.• Airbag control module is faulty.	<Ref. to AB-82, TROUBLE CODE 66, Diagnostic Chart with Trouble Code.>

LIST OF DIAGNOSTIC TROUBLE CODE

AIRBAG SYSTEM (DIAGNOSTICS)

DIAGNOSTIC CHART WITH TROUBLE CODE

AIRBAG SYSTEM (DIAGNOSTICS)

13. Diagnostic Chart with Trouble Code

A: TROUBLE CODE 11

DIAGNOSIS:

- Airbag main harness circuit is open, shorted or shorted to ground.
- Airbag module harness (Driver) circuit is open, shorted or shorted to ground.
- Roll connector circuit is open, shorted or shorted to ground.
- Driver's airbag module is faulty.
- Airbag control module is faulty.

CAUTION:

- Before diagnosing the airbag system, be sure to turn the ignition switch OFF, disconnect the ground cable from the battery, and wait more than 20 seconds before starting to work.
- Before replacing the airbag module, roll controller, control module, and sensor, reconnect each part and confirm that the warning light operates properly.
- When inspecting the airbag main harness, disconnect the driver's airbag module and passenger's airbag module connectors for safety reasons.

WIRING DIAGRAM:

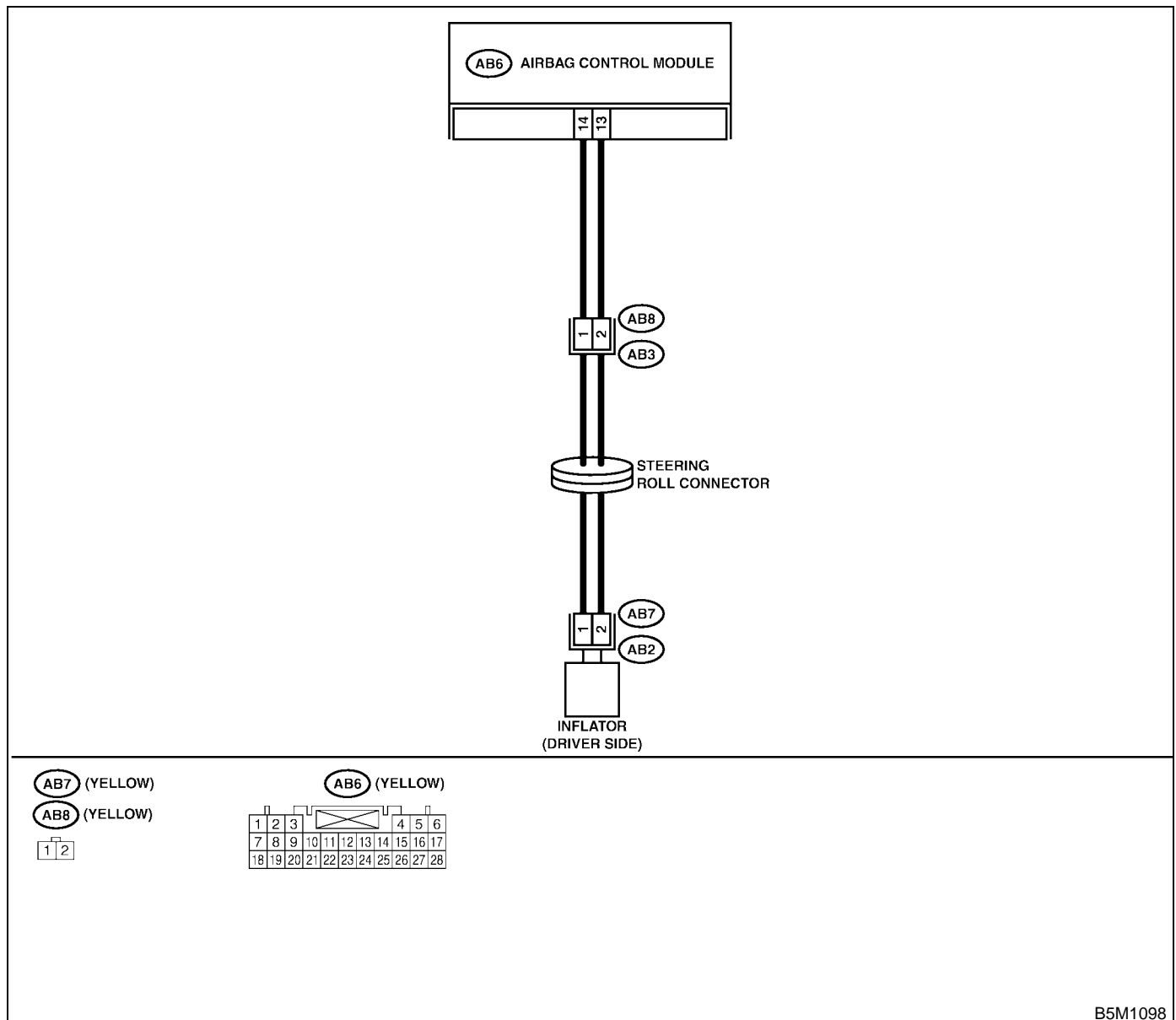

B5M1098

DIAGNOSTIC CHART WITH TROUBLE CODE

AIRBAG SYSTEM (DIAGNOSTICS)

Step	Check	Yes	No
1 CHECK DRIVER'S AIRBAG MODULE. 1) Turn the ignition switch OFF, disconnect battery ground cable, and wait more than 20 seconds. 2) Remove the driver's airbag module. <Ref. to AB-12, Driver's Airbag Module.> 3) Connect the connector (1F) in test harness F to connector (AB7). 4) Connect airbag resistor to connector (3F) in test harness F. 5) Connect the battery ground cable and turn the ignition switch ON.	Does the airbag warning light operate properly?	Replace the driver's airbag module. <Ref. to AB-12, Driver's Airbag Module.>	Go to step 2.
2 CHECK ROLL CONNECTOR. 1) Turn the ignition switch OFF, disconnect the battery ground cable, and wait more than 20 second. 2) Disconnect the test harness F from the connector (AB7). 3) Remove the lower cover panel, disconnect the connector (AB3) from (AB8) and connect the connector (1F) in test harness F to connector (AB8). 4) Connect the airbag resistor to connector (3F) in test harness F. 5) Connect the battery ground cable and turn the ignition switch ON.	Does the airbag warning light operate properly?	Replace the roll connector. <Ref. to AB-18, Roll Connector.>	Go to step 3.
3 CHECK AIRBAG MAIN HARNESS. 1) Turn the ignition switch OFF, disconnect the ground cable, and wait more than 20 seconds. 2) Disconnect the airbag resistor from the connector (3F) in test harness F. 3) Remove the glove box, <Ref. to AB-14, Passenger's Airbag Module.> and disconnect connectors (AB10) and (AB9). 4) Disconnect the connector (AB6) from the airbag control module, and connect the connector (1I) in test harness I or I2. <Ref. to AB-16, Airbag Control Module.> 5) Measure the resistance between connector (2I) in test harness I or I2 and the connector (3F) in test harness F. Connector & terminal (2I) No. 1 — (3F) No. 4: (2I) No. 4 — (3F) No. 3:	Is the resistance less than 10 Ω ?	Go to step 4.	Replace the body harness with airbag main harness.
4 CHECK AIRBAG MAIN HARNESS. Measure the resistance of the connector (2I) in test harness I or I2. Connector & terminal (2I) No. 1 — No. 4: (2I) No. 4 — Chassis ground: (2I) No. 1 — Chassis ground:	Is the resistance more than 1 M Ω ?	Replace the airbag control module. <Ref. to AB-16, Airbag Control Module.>	Replace the body harness with airbag main harness.

DIAGNOSTIC CHART WITH TROUBLE CODE

AIRBAG SYSTEM (DIAGNOSTICS)

B: TROUBLE CODE 12

DIAGNOSIS:

- Airbag main harness circuit is open, shorted or shorted to ground.
- Airbag module harness (Passenger) circuit is open, shorted or shorted to ground.
- Passenger's airbag module is faulty.
- Airbag control module is faulty.

CAUTION:

- Before diagnosing the airbag system, be sure to turn the ignition switch OFF, disconnect the ground cable from the battery, and wait more than 20 seconds before starting to work.
- Before replacing the airbag module, roll connector, control module, and sensor, reconnect each part and confirm that the warning light operates properly.
- When inspecting the airbag main harness, disconnect the airbag module connector of the driver and passenger seats for safety reasons.

WIRING DIAGRAM:

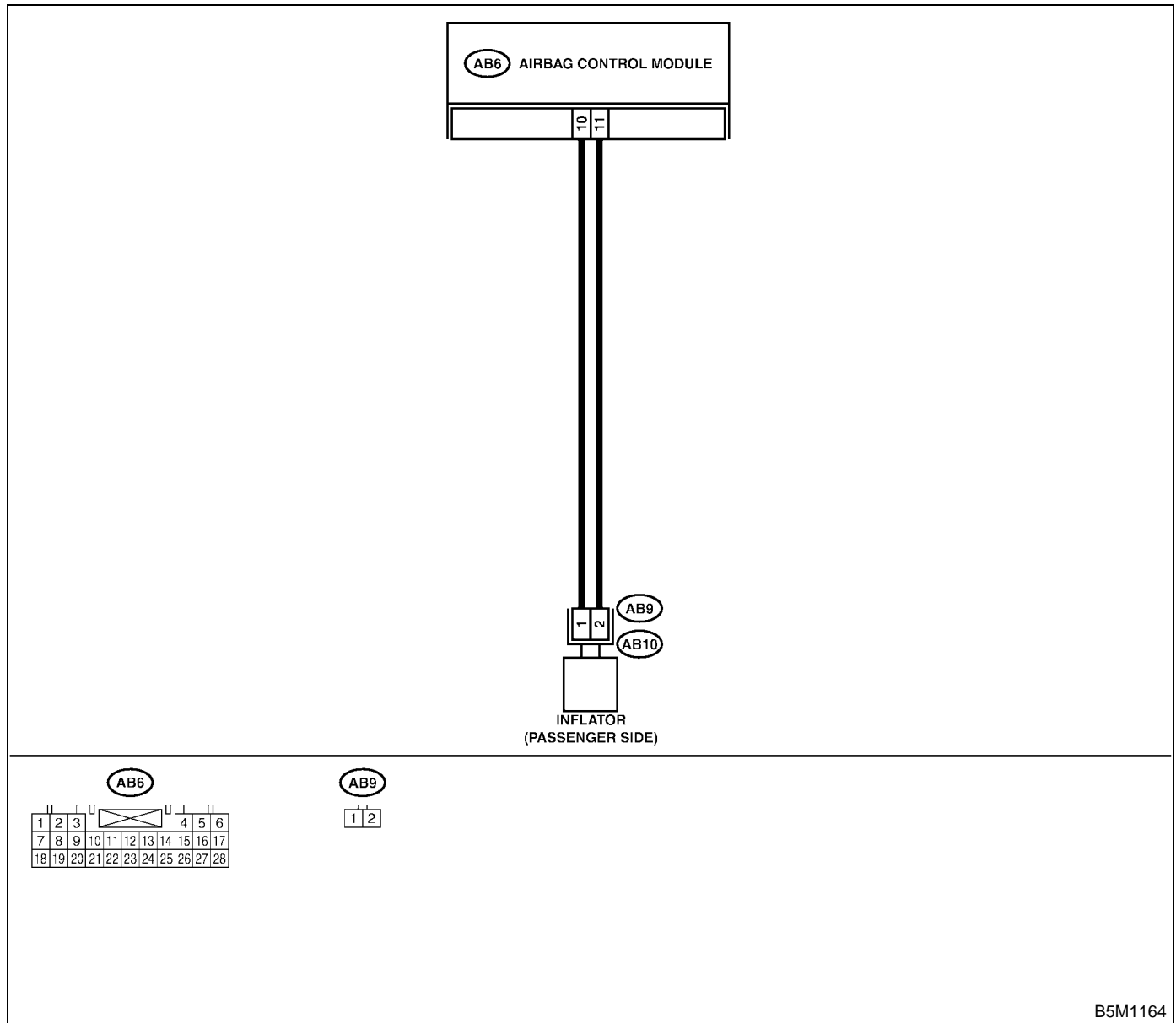

B5M1164

DIAGNOSTIC CHART WITH TROUBLE CODE

AIRBAG SYSTEM (DIAGNOSTICS)

Step	Check	Yes	No
1 CHECK PASSENGER'S AIRBAG MODULE. 1) Turn the ignition switch OFF, disconnect the battery ground cable, and wait more than 20 seconds. 2) Pull out the two stopper pins and lower the glove box. 3) Disconnect the connector (AB10) from (AB9). 4) Connect the connector (1F) in test harness F to connector (AB9). 5) Connect the airbag resistor to connector (3F) in test harness F. 6) Connect the battery ground cable and turn the ignition switch ON.	Does the airbag warning light operate properly?	Replace the passenger airbag module. <Ref. to AB-14, Passenger's Airbag Module.>	Go to step 2.
2 CHECK AIRBAG MAIN HARNESS. 1) Turn the ignition switch OFF, disconnect the battery ground cable, and wait more than 20 seconds. 2) Disconnect the airbag resistor from the connector (3F) in test harness F. 3) Remove lower cover and disconnect the connector (AB3) from (AB8). 4) Disconnect the connector (AB6) from the airbag control module, and connect the connector (1I) in test harness I or I2. <Ref. to AB-16, Airbag Control Module.> 5) Measure the resistance between connector (2I) in test harness I or I2 and the connector (3F) in test harness F. Connector & terminal (2I) No. 2 — (3F) No. 4: (2I) No. 5 — (3F) No. 3:	Is the resistance less than 10 Ω?	Go to step 3.	Replace the body harness with airbag main harness.
3 CHECK AIRBAG MAIN HARNESS. Measure the resistance of the connector (2I) in test harness I or I2. Connector & terminal (2I) No. 2 — No. 5: (2I) No. 2 — Chassis ground: (2I) No. 5 — Chassis ground:	Is the resistance more than 1 MΩ?	Replace airbag control module. <Ref. to AB-16, Airbag Control Module.>	Replace the body harness with airbag main harness.

DIAGNOSTIC CHART WITH TROUBLE CODE

AIRBAG SYSTEM (DIAGNOSTICS)

C: TROUBLE CODE 15

DIAGNOSIS:

- Airbag main harness circuit (Driver) is shorted to the power supply.
- Airbag module harness (Driver) is shorted to the power supply.
- Roll connector is shorted to the power supply.
- Driver's airbag module is faulty.
- Airbag control module is faulty.

CAUTION:

- Before diagnosing the airbag system, be sure to turn the ignition switch OFF, disconnect the ground cable from the battery, and wait more than 20 seconds before starting to work.
- Before replacing the airbag module, roll connector, control module, and sensor, reconnect each part and confirm that the warning light operates properly.
- When inspecting the airbag main harness, disconnect the driver's airbag module and passenger's airbag module connectors for safety reasons.

WIRING DIAGRAM:

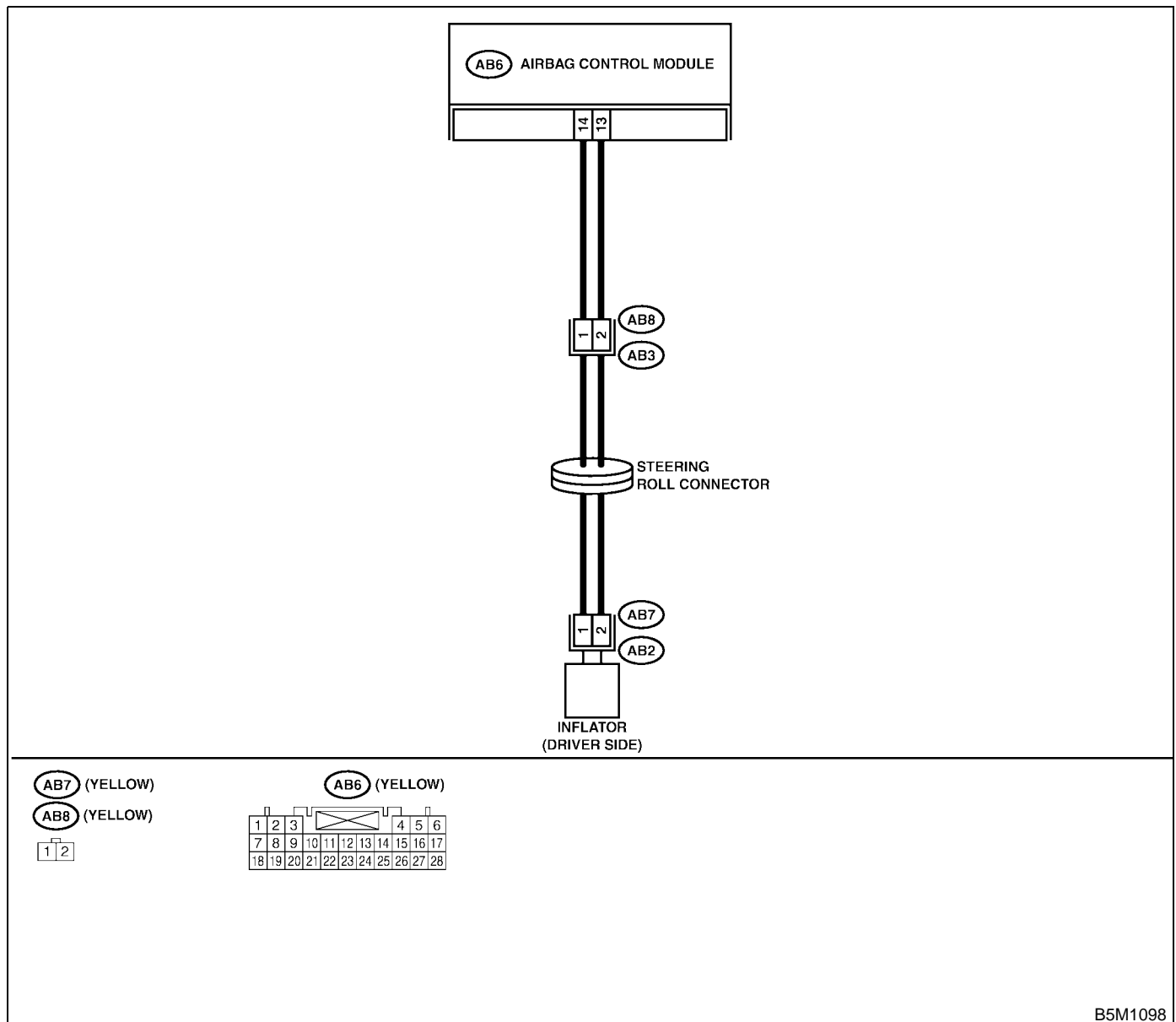

B5M1098

DIAGNOSTIC CHART WITH TROUBLE CODE

AIRBAG SYSTEM (DIAGNOSTICS)

Step	Check	Yes	No
1 CHECK DRIVER'S AIRBAG MODULE. 1) Turn the ignition switch OFF, disconnect the battery ground cable, and wait more than 20 seconds. 2) Remove the driver's airbag module. <Ref. to AB-12, Driver's Airbag Module.> 3) Connect the connector (AB7) to connector (1F) in test harness F. 4) Connect the airbag resistor to connector (3F) in test harness F. 5) Connect the battery ground cable and turn the ignition switch ON.	Does the airbag warning light operate properly?	Replace the driver's airbag module. <Ref. to AB-12, Driver's Airbag Module.>	Go to step 2.
2 CHECK ROLL CONNECTOR. 1) Turn the ignition switch OFF, disconnect the battery ground cable, and wait more than 20 seconds. 2) Disconnect the test harness F from the connector (AB7). 3) Remove the lower cover panel and disconnect the connector (AB3) from (AB8). 4) Connect the connector (1F) in test harness F to connector (AB8). 5) Connect the airbag resistor to connector (3F) in test harness F. 6) Connect the battery ground cable and turn the ignition switch ON.	Does the airbag warning light operate properly?	Replace the roll connector. <Ref. to AB-18, Roll Connector.>	Go to step 3.
3 CHECK AIRBAG MAIN HARNESS. 1) Turn the ignition switch OFF, disconnect the battery ground cable, and wait more than 20 seconds. 2) Disconnect the airbag resistor from the connector (3F) in test harness F. 3) Remove glove box, and disconnect connectors (AB10) and (AB9). 4) Disconnect the connector (AB6) from the airbag control module, and connect the connector (1I) in test harness I or I2. <Ref. to AB-16, Airbag Control Module.> 5) Connect the battery ground cable and turn the ignition switch ON. (Engine OFF) 6) Measure the voltage between connector (2I) in test harness I or I2 and the chassis ground. Connector & terminal (2I) No. 4 (+) — Chassis ground (-): (2I) No. 1 (+) — Chassis ground (-):	Is the voltage less than 1 V?	Replace the airbag control module. <Ref. to AB-16, Airbag Control Module.>	Replace the body harness with airbag main harness.

DIAGNOSTIC CHART WITH TROUBLE CODE

AIRBAG SYSTEM (DIAGNOSTICS)

D: TROUBLE CODE 16

DIAGNOSIS:

- Airbag main harness circuit (Passenger) is shorted to the power supply.
- Airbag module harness (Passenger) is shorted to the power supply.
- Passenger's airbag module is faulty.
- Airbag control module is faulty.

CAUTION:

- Before diagnosing the airbag system, be sure to turn the ignition switch OFF, disconnect the ground cable from the battery, and wait more than 20 seconds before starting to work.
- Before replacing the airbag module, roll connector, control module, and sensor, reconnect each part and confirm that the warning light operates properly.
- When inspecting the airbag main harness, disconnect the airbag module connector of the driver and passenger seats for safety reasons.

WIRING DIAGRAM:

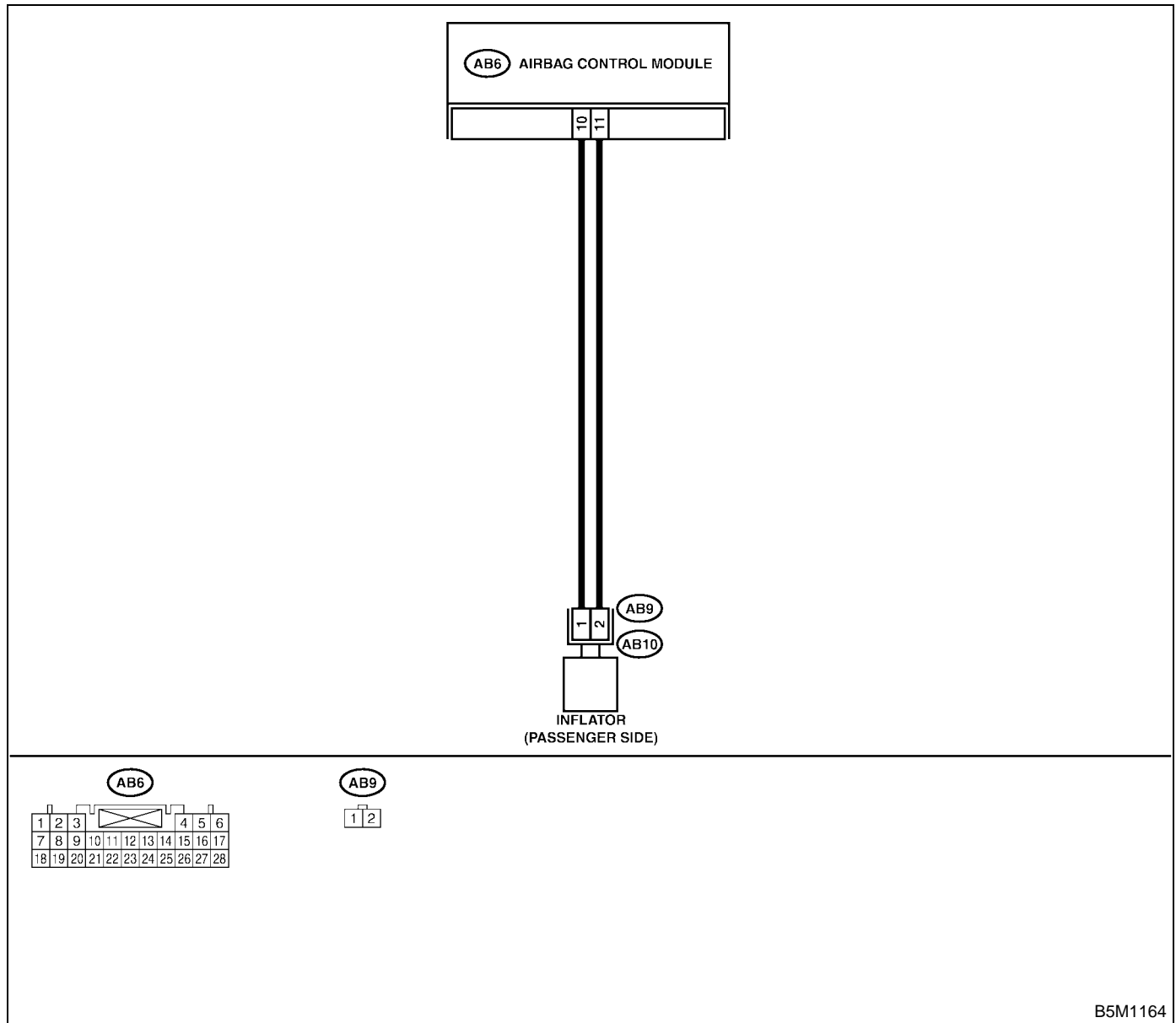

B5M1164

DIAGNOSTIC CHART WITH TROUBLE CODE

AIRBAG SYSTEM (DIAGNOSTICS)

Step	Check	Yes	No
1 CHECK PASSENGER'S AIRBAG MODULE. 1) Turn the ignition switch OFF, disconnect the battery ground cable, and wait more than 20 seconds. 2) Remove the glove box. 3) Disconnect the connector (AB10) from (AB9) 4) Connect the connector (1F) in test harness F to connector (AB9). 5) Connect the airbag resistor to connector (3F) in test harness F. 6) Connect the battery ground cable and turn the ignition switch ON.	Does the airbag warning light operate properly?	Replace the passenger airbag module. <Ref. to AB-14, Passenger's Airbag Module.>	Go to step 2.
2 CHECK AIRBAG MAIN HARNESS. 1) Turn the ignition switch OFF, disconnect the battery ground cable, and wait more than 20 seconds. 2) Disconnect the airbag resistor from the connector (3F) in test harness F. 3) Remove the lower cover and disconnect the connector (AB3) from (AB8). 4) Disconnect the connector (AB6) from the airbag control module, and connect the connector (1I) in test harness I or I2. <Ref. to AB-16, Airbag Control Module.> 5) Measure the voltage between connector (2I) in test harness I or I2 and the chassis ground. Connector & terminal (2I) No. 2 — Chassis ground: (2I) No. 5 — Chassis ground:	Is the voltage less than 1 V?	Replace the airbag control module. <Ref. to AB-16, Airbag Control Module.>	Replace the body harness with airbag main harness.

E: TROUBLE CODE 21

DIAGNOSIS:

- Airbag control module is faulty.

CAUTION:

- Before diagnosing the airbag system, be sure to turn the ignition switch OFF, disconnect the ground cable from the battery, and wait more than 20 seconds before starting to work.
- Before replacing the airbag module, roll connector, control module, and sensor, reconnect each part and confirm that the warning light operates properly.

Step	Check	Yes	No
1 CHECK IF TROUBLE CODE 21 IS INDICATED. Read Diagnostic Trouble Code. <Ref. to AB-29, Read Diagnostic Trouble Code.>	Is airbag warning light trouble code 21 indicated?	Replace the airbag control module. <Ref. to AB-16, Airbag Control Module.>	Perform clear memory. <Ref. to AB-31, Clear Memory Mode.>

DIAGNOSTIC CHART WITH TROUBLE CODE

AIRBAG SYSTEM (DIAGNOSTICS)

F: TROUBLE CODE 22

WIRING DIAGRAM:

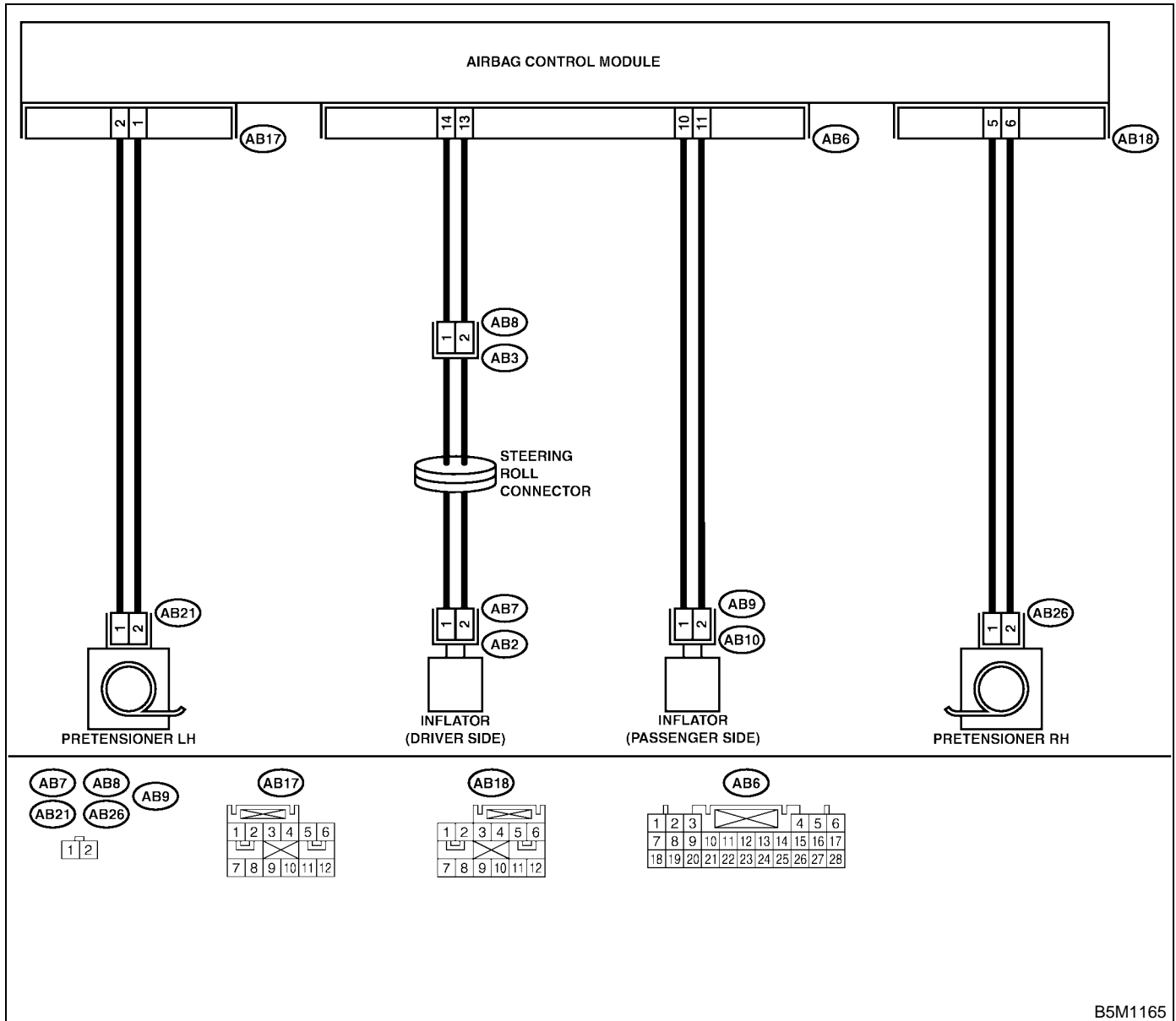

This code is indicated when the front airbag and the pretensioner are in operation.

Once this code is indicated, memory is not erasable; therefore change the following parts.

- Airbag control module. <Ref. to AB-16, Airbag Control Module.>
- Driver's airbag module. <Ref. to AB-12, Driver's Airbag Module.>
- Passenger's airbag module. <Ref. to AB-14, Passenger's Airbag Module.>
- Front sub-sensor of both sides. <Ref. to AB-19, Front Sub Sensor.>
- Front seat belt outer with pretensioner of both sides. <Ref. to SB-8, Front Seat Belt.>

DIAGNOSTIC CHART WITH TROUBLE CODE

AIRBAG SYSTEM (DIAGNOSTICS)

G: TROUBLE CODE 23

DIAGNOSIS:

(AB6), (AB17) and (AB18) are not connected properly to airbag control module.

CAUTION:

Before diagnosing the airbag system, be sure to turn the ignition switch OFF, disconnect the ground cable from the battery, and wait more than 20 seconds before starting to work.

	Step	Check	Yes	No
1	CHECK POOR CONTACT IN CONECTORS (AB6), (AB17) and (AB18). 1) Turn the ignition switch OFF, disconnect the battery ground cable, and wait more than 20 seconds. 2) Disconnect the connectors (AB6), (AB17) and (AB18) from the airbag control module. <Ref. to AB-16, Airbag Control Module.>	Check if rust or damage appear on the harness connector and the control module connector.	Replace the airbag control module. <Ref. to AB-16, Airbag Control Module.> Replace the body harness with airbag main harness. Replace the body harness with side airbag harness.	Go to step 2.
2	CHECK POOR CONTACT IN CONECTORS (AB6), (AB17) and (AB18). 1) Ensure that connectors are firmly reconnected. 2) Connect the battery ground cable and turn the ignition switch ON.	Does the airbag warning light operate properly?	Finish the diagnosis.	Replace the airbag control module. <Ref. to AB-16, Airbag Control Module.>

DIAGNOSTIC CHART WITH TROUBLE CODE

AIRBAG SYSTEM (DIAGNOSTICS)

H: TROUBLE CODE 24

DIAGNOSIS:

- Airbag control module is faulty.
- Airbag main harness circuit is open.
- Fuse No, 11 (in joint box) is blown.
- Body harness circuit is open.

CAUTION:

- Before diagnosing the airbag system, be sure to turn the ignition switch OFF, disconnect the ground cable from the battery, and wait more than 20 seconds before starting to work.
- Before replacing the airbag module, roll connector, control module, and sensor, reconnect each part and confirm that the warning light operates properly.
- When inspecting the airbag main harness, disconnect the driver's airbag module and passenger's airbag module connectors for safety reasons.

WIRING DIAGRAM:

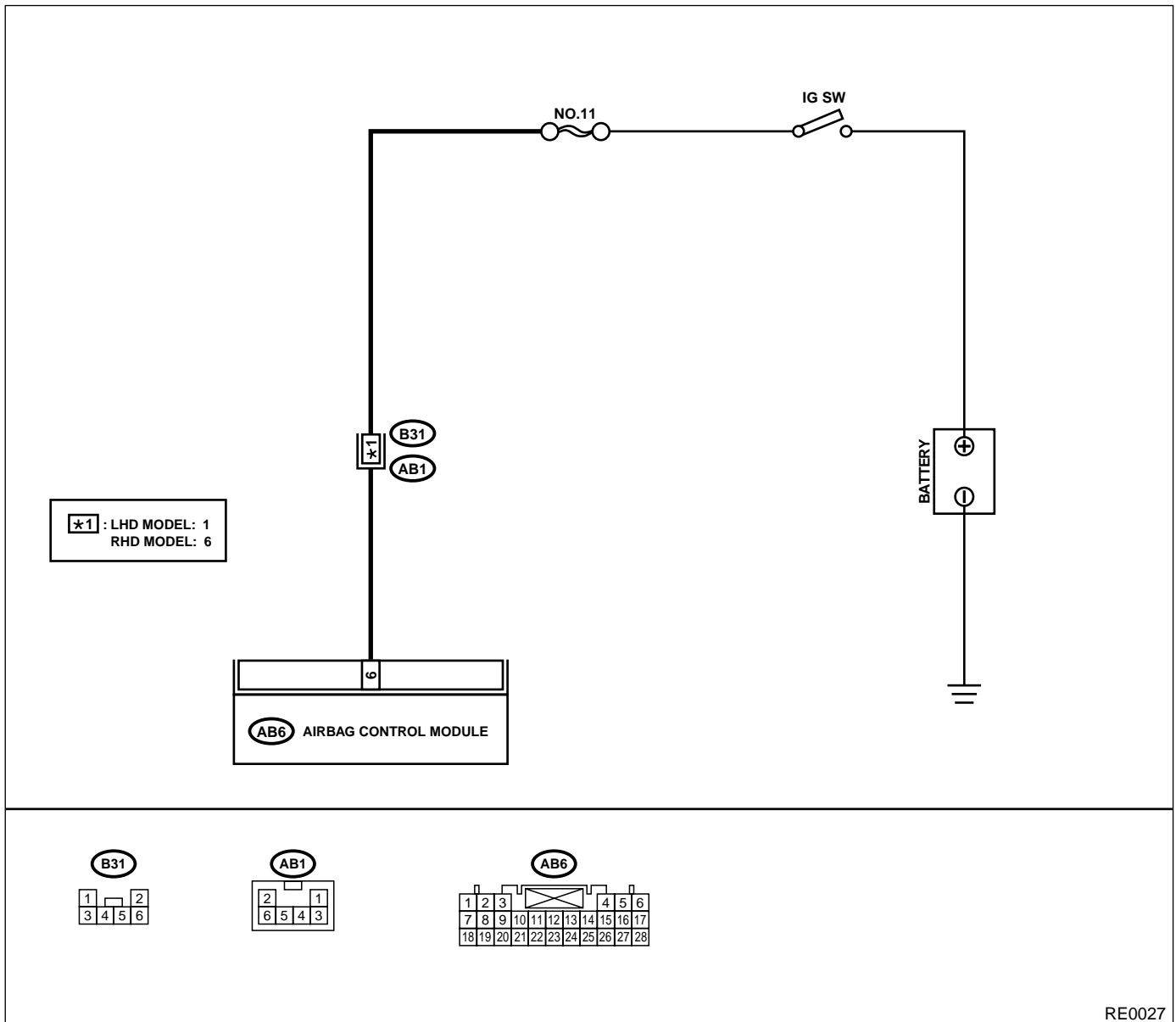

RE0027

DIAGNOSTIC CHART WITH TROUBLE CODE

AIRBAG SYSTEM (DIAGNOSTICS)

Step	Check	Yes	No
<p>1</p> <p>CHECK AIRBAG CONTROL MODULE. 1) Turn the ignition switch OFF, disconnect the battery ground cable, and wait more than 20 seconds. 2) Disconnect the connector (AB6) from the airbag control module. <Ref. to AB-16, Airbag Control Module.> 3) Connect the connector (1I) in test harness I or I2 to connector (AB6). 4) Connect the battery ground cable and turn the ignition switch ON. 5) Measure the voltage between connector (2I) in test harness I or I2 and chassis ground.</p> <p>Connector & terminal (2I) No. 3 (+) — Chassis ground (-):</p>	<p>Is the voltage more than 10 V?</p>	<p>Replace the airbag control module. <Ref. to AB-16, Airbag Control Module.></p>	<p>Go to step 2.</p>
<p>2</p> <p>CHECK AIRBAG MAIN HARNESS. 1) While checking control module, turn the ignition switch OFF and disconnect the battery ground cable. Wait more than 20 seconds before operation. 2) Disconnect the airbag connector (AB1) from the body harness (B31). 3) Connect the connector (2M) in test harness M to connector (AB1). 4) Measure the resistance between connector (5M) in test harness M and the connector (2I) in test harness I or I2.</p> <p>Connector & terminal LHD MODEL: (5M) No. 2 — (2I) No. 3: RHD MODEL: (5M) No. 9 — (2I) No. 3:</p>	<p>Is the resistance less than 10 Ω?</p>	<p>Go to step 3.</p>	<p>Replace the body harness with airbag main harness.</p>
<p>3</p> <p>CHECK AIRBAG MAIN HARNESS. Measure the following resistance with the above-mentioned condition maintained.</p> <p>Connector & terminal LHD MODEL: (5M) No. 2 — Chassis ground: (2I) No. 3 — Chassis ground: RHD MODEL: (5M) No. 9 — Chassis ground: (2I) No. 3 — Chassis ground:</p>	<p>Is the resistance more than 1 MΩ?</p>	<p>Go to step 4.</p>	<p>Replace the body harness with airbag main harness.</p>
<p>4</p> <p>CHECK FUSE No. 11 (IN JOINT BOX). 1) Confirm that the ignition switch is turned OFF. 2) Remove fuse No. 11 (in joint box) and perform visual inspection.</p>	<p>Is fuse No. 11 blown?</p>	<p>Replace fuse No. 11. If fuse No. 11 blows again, repair the body harness.</p>	<p>Repair the body harness.</p>

DIAGNOSTIC CHART WITH TROUBLE CODE

AIRBAG SYSTEM (DIAGNOSTICS)

I: TROUBLE CODE 25

DIAGNOSIS:

- Airbag control module is faulty.
- Airbag main harness circuit is open.
- Fuse No. 6 (in joint box) is blown.
- Body harness circuit is open.

CAUTION:

- Before diagnosing the airbag system, be sure to turn the ignition switch OFF, disconnect the ground cable from the battery, and wait more than 20 seconds before starting to work.
- Before replacing the airbag module, roll connector, control module, and sensor, reconnect each part and confirm that the warning light operates properly.
- When inspecting the airbag main harness, disconnect the driver's airbag module and passenger's airbag module connectors for safety reasons.

WIRING DIAGRAM:

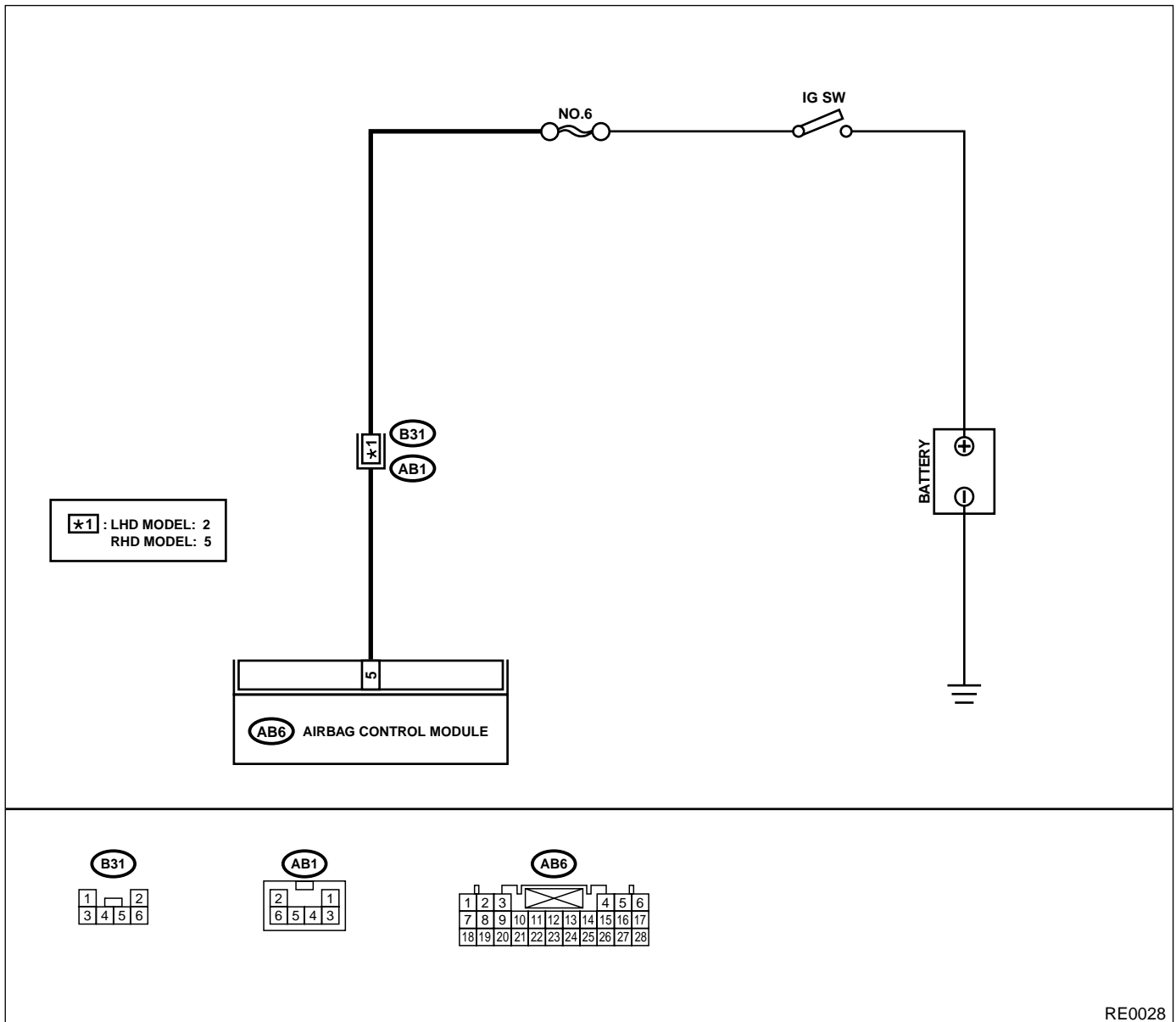

RE0028

DIAGNOSTIC CHART WITH TROUBLE CODE

AIRBAG SYSTEM (DIAGNOSTICS)

Step	Check	Yes	No
<p>1</p> <p>CHECK AIRBAG CONTROL MODULE. 1) Turn the ignition switch OFF, disconnect the battery ground cable, and wait more than 20 seconds. 2) Disconnect the connector (AB6) from airbag control module. <Ref. to AB-16, Airbag Control Module.> 3) Connect the connector (1I) in test harness I or I2 to connector (AB6). 4) Connect the battery ground cable, and turn the ignition switch ON. 5) Measure the voltage between the connector (2I) in test harness I or I2 and the chassis ground.</p> <p>Connector & terminal (2I) No. 6 (+) — Chassis ground (-):</p>	<p>Is the voltage more than 10 V?</p>	<p>Replace the airbag control module. <Ref. to AB-16, Airbag Control Module.></p>	<p>Go to step 2.</p>
<p>2</p> <p>CHECK AIRBAG MAIN HARNESS. 1) While checking control module, turn the ignition switch OFF and disconnect the battery ground cable. Wait more than 20 seconds before operation. 2) Disconnect the airbag connector (AB1) from the body harness (B31). 3) Connect the connector (2M) in test harness M to the airbag connector (AB1). 4) Measure the resistance between the connector (5M) in test harness M and the connector (2I) in test harness I or I2.</p> <p>Connector & terminal LHD MODEL: (5M) No. 2 — (2I) No. 6: RHD MODEL: (5M) No. 1 — (2I) No. 6:</p>	<p>Is the resistance less than 10 Ω?</p>	<p>Go to step 3.</p>	<p>Replace the body harness with airbag main harness.</p>
<p>3</p> <p>CHECK AIRBAG MAIN HARNESS. Measure the following resistance with the above-mentioned condition maintained.</p> <p>Connector & terminal LHD MODEL: (5M) No. 2 — Chassis ground: (2I) No. 6 — Chassis ground: RHD MODEL: (5M) No. 1 — Chassis ground: (2I) No. 6 — Chassis ground:</p>	<p>Is the resistance more than 1 MΩ?</p>	<p>Go to step 4.</p>	<p>Replace the body harness with airbag main harness.</p>
<p>4</p> <p>CHECK FUSE NO. 6 (IN JOINT BOX). 1) Confirm that the ignition switch is turned OFF. 2) Remove No. 6 fuse (in joint box) and perform visual inspection.</p>	<p>Is fuse No. 6 blown?</p>	<p>Replace fuse No. 6. If fuse No. 6 is blown again, repair the body harness.</p>	<p>Repair the body harness.</p>

DIAGNOSTIC CHART WITH TROUBLE CODE

AIRBAG SYSTEM (DIAGNOSTICS)

J: TROUBLE CODE 31

DIAGNOSIS:

- Front sub-sensor harness (RH) circuit is shorted.
- Front sub-sensor harness (RH) circuit is open.
- Front sub-sensor (RH) is faulty.
- Airbag control module is faulty.

CAUTION:

- Before diagnosing the airbag system, be sure to turn the ignition switch OFF, disconnect the ground cable from the battery, and wait more than 20 seconds before starting to work.
- Before replacing the airbag module, roll connector, control module, and sensor, reconnect each part and confirm that the warning light operates properly.
- When inspecting the airbag main harness, disconnect the driver's airbag module and passenger's airbag module connectors for safety reasons.

WIRING DIAGRAM:

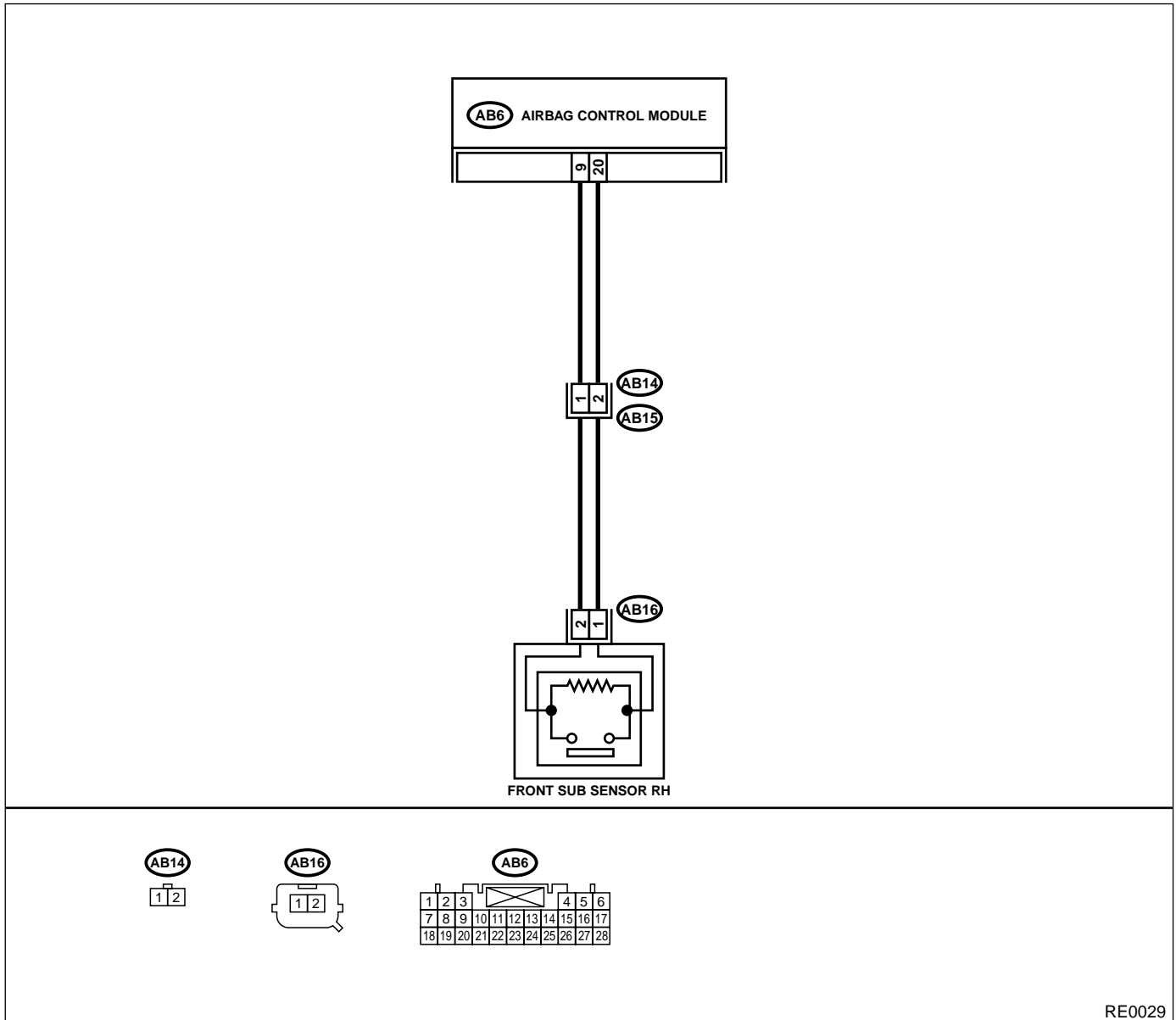

RE0029

DIAGNOSTIC CHART WITH TROUBLE CODE

AIRBAG SYSTEM (DIAGNOSTICS)

Step	Check	Yes	No
1 CHECK FRONT SUB-SENSOR (RH) AND FRONT SUB-SENSOR HARNESS (RH). 1) Turn the ignition switch OFF, disconnect the battery ground cable, and wait more than 20 seconds. 2) Disconnect the connector (AB6) from the airbag control module, and connect the connector (1I) in test harness I or I2. <Ref. to AB-16, Airbag Control Module.> 3) Measure the resistance of the connector (3I) in test harness I or I2. Connector & terminal (3I) No. 2 — No. 4:	Is the resistance between 750Ω and 1 KΩ?	Replace the airbag control module. <Ref. to AB-16, Airbag Control Module.>	Go to step 2.
2 CHECK FRONT SUB-SENSOR (RH) AND FRONT SUB-SENSOR HARNESS (RH). Measure the resistance between connector (3I) in test harness I or I2 and the chassis ground. Connector & terminal (3I) No. 2 — Chassis ground: (3I) No. 4 — Chassis ground:	Is the resistance more than 1 MΩ?	Replace the airbag control module. <Ref. to AB-16, Airbag Control Module.>	Go to step 3.
3 CHECK AIRBAG MAIN HARNESS AND FRONT SUB-SENSOR HARNESS (RH). 1) Disconnect connector (AB16) from the front sub-sensor. <Ref. to AB-19, Front Sub Sensor.> 2) Connect connector (IH) in test harness H to connector (AB16). 3) Measure the resistance between connector (3I) in test harness I or I2 and connector (3H) in test harness H. Connector & terminal (3I) No. 2 — (3H) No. 5: (3I) No. 4 — (3H) No. 6:	Is the resistance less than 10Ω?	Go to step 4.	Go to step 5.
4 CHECK AIRBAG MAIN HARNESS AND FRONT SUB-SENSOR HARNESS (RH). Measure the resistance between connector (3I) in test harness I or I2 and the chassis ground. Connector & terminal (3I) No. 2 — Chassis ground: (3I) No. 4 — Chassis ground:	Is the resistance more than 1 MΩ?	Go to step 9.	Go to step 5.
5 CHECK AIRBAG MAIN HARNESS 1) Disconnect connector (AB15) from (AB14), and connect connector (1F) in test harness F to connector (AB14). 2) Measure the resistance between connector (3I) in test harness I or I2 and connector (3F) in test harness F. Connector & terminal (3I) No. 2 — (3F) No. 4: (3I) No. 4 — (3F) No. 3:	Is the resistance less than 10 Ω?	Go to step 6.	Replace the body harness with airbag main harness.
6 CHECK AIRBAG MAIN HARNESS Measure the resistance between connector (3I) in test harness I or I2 and the chassis ground. Connector & terminal (3I) No. 2 — Chassis ground: (3I) No. 4 — Chassis ground:	Is the resistance more than 1 MΩ?	Go to step 7.	Replace the body harness with airbag main harness.

DIAGNOSTIC CHART WITH TROUBLE CODE

AIRBAG SYSTEM (DIAGNOSTICS)

Step	Check	Yes	No
7 CHECK FRONT SUB-SENSOR HARNESS (RH). 1)Connect connector (2F) in test harness F to the connector (AB15). 2)Measure the resistance between connector (3H) in test harness H and connector (3F) in the test harness F. Connector & terminal (3F) No. 5 — (3H) No. 5: (3F) No. 6 — (3H) No. 6:	Is the resistance less than 10 Ω ?	Go to step 8 .	Replace the body harness with front sub-sensor harness (RH).
8 CHECK FRONT SUB-SENSOR HARNESS (RH). Measure the resistance between connector (3F) in test harness F and the chassis ground. Connector & terminal (3F) No. 5 — Chassis ground: (3F) No. 6 — Chassis ground:	Is the resistance more than 1 M Ω ?	Go to step 9 .	Replace the body harness with front sub-sensor harness (RH).
9 CHECK FRONT SUB-SENSOR (RH). 1)Connect connector (2H) in test harness H to front sub-sensor (RH). 2)Measure the resistance of the connector (3H) in test harness H. Connector & terminal (3H) No. 3 — No. 4:	Is the resistance between 750 Ω and 1 K Ω ?	Go to step 10 .	Replace the front sub-sensor (RH). <Ref. to AB-19, Front Sub Sensor.>
10 CHECK FRONT SUB-SENSOR (RH). Measure the resistance between connector (3H) in test harness H and the chassis ground. Connector & terminal (3H) No. 3 — Chassis ground: (3H) No. 4 — Chassis ground:	Is the resistance more than 1 M Ω ?	Finish the diagnosis.	Replace the front sub-sensor (RH). <Ref. to AB-19, Front Sub Sensor.>

DIAGNOSTIC CHART WITH TROUBLE CODE

AIRBAG SYSTEM (DIAGNOSTICS)

DIAGNOSTIC CHART WITH TROUBLE CODE

AIRBAG SYSTEM (DIAGNOSTICS)

K: TROUBLE CODE 32

DIAGNOSIS:

- Front sub-sensor harness (LH) circuit is shorted.
- Front sub-sensor harness (LH) circuit is open.
- Front sub-sensor (LH) is faulty.
- Airbag control module is faulty.

CAUTION:

- Before diagnosing the airbag system, be sure to turn the ignition switch OFF, disconnect the ground cable from the battery, and wait more than 20 seconds before starting to work.
- Before replacing the airbag module, roll connector, control module, and sensor, reconnect each part and confirm that the warning light operates properly.
- When inspecting the airbag main harness, disconnect the driver's airbag module and passenger's airbag module connectors for safety reasons.

WIRING DIAGRAM:

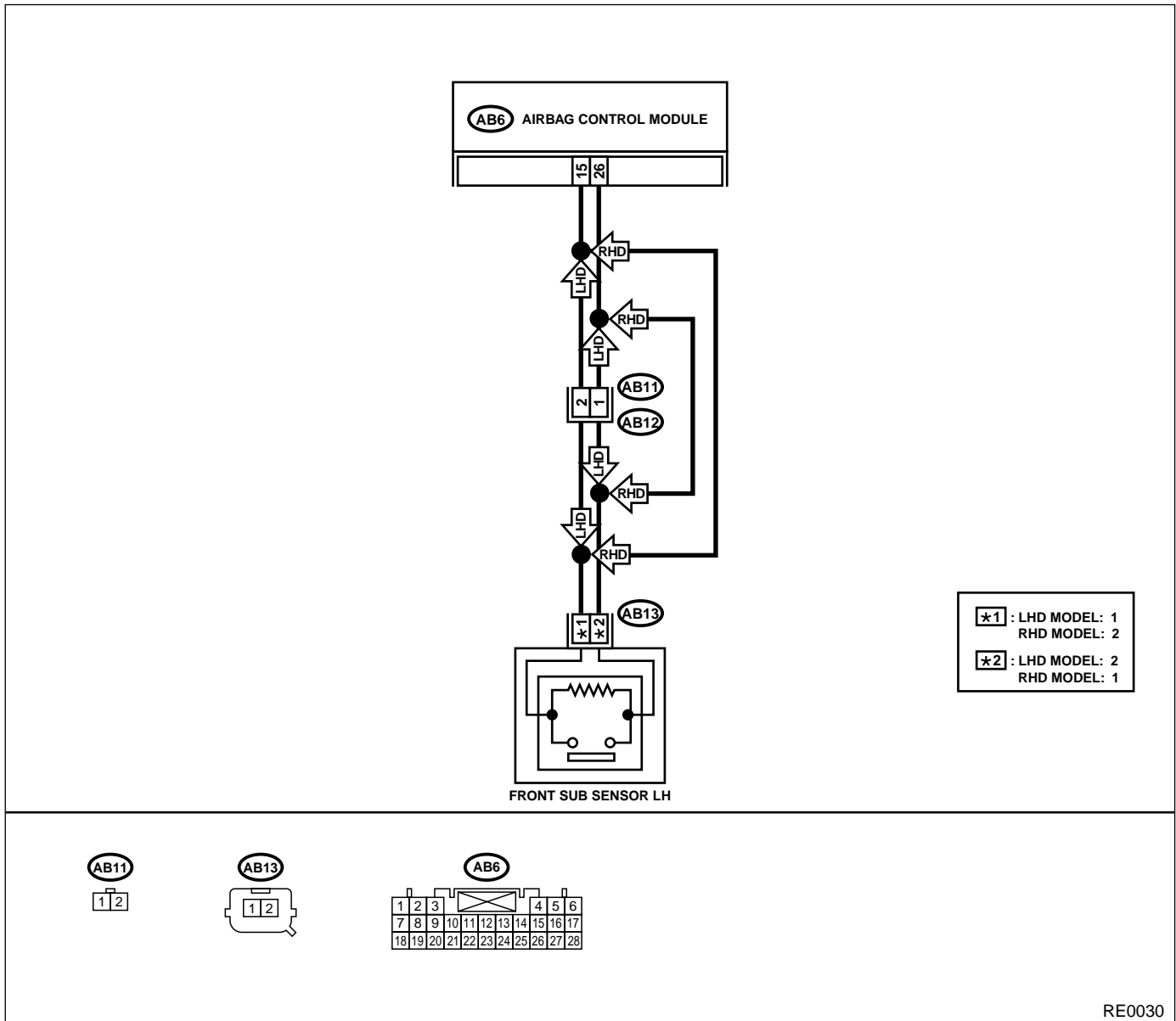

RE0030

DIAGNOSTIC CHART WITH TROUBLE CODE

AIRBAG SYSTEM (DIAGNOSTICS)

Step	Check	Yes	No
<p>1 CHECK FRONT SUB-SENSOR (LH) AND FRONT SUB-SENSOR HARNESS (RH). 1) Turn the ignition switch OFF, disconnect the battery ground cable, and wait more than 20 seconds. 2) Disconnect connector (AB6) from the airbag control module, and connect connector (1I) in the test harness I or I2 to connector (AB6). <Ref. to AB-16, Airbag Control Module.> 3) Measure the resistance of the connector (3I) in the test harness I or I2.</p> <p>Connector & terminal (3I) No. 1 — No. 3:</p>	<p>Is the resistance between 750Ω and 1 KΩ?</p>	<p>Replace the airbag control module. <Ref. to AB-16, Airbag Control Module.></p>	<p>Go to step 2.</p>
<p>2 CHECK FRONT SUB-SENSOR (LH) AND FRONT SUB-SENSOR HARNESS (RH). Measure the resistance between connector (3I) in test harness I or I2 and the chassis ground.</p> <p>Connector & terminal (3I) No. 1 — Chassis ground: (3I) No. 3 — Chassis ground:</p>	<p>Is the resistance more than 1 MΩ?</p>	<p>Replace the airbag control module. <Ref. to AB-16, Airbag Control Module.></p>	<p>Go to step 3.</p>
<p>3 CHECK AIRBAG MAIN HARNESS AND FRONT SUB-SENSOR HARNESS (LH). 1) Disconnect the connector (AB13) from the front sub-sensor. <Ref. to AB-19, Front Sub Sensor.> 2) Connect connector (1H) in test harness H to connector (AB13). 3) Measure the resistance between connector (3I) in test harness I or I2 and connector (3H) in test harness H.</p> <p>Connector & terminal LHD MODEL: (3I) No. 3 — (3H) No. 6: (3I) No. 1 — (3H) No. 5: RHD MODEL: (3I) No. 3 — (3H) No. 5: (3I) No. 1 — (3H) No. 6:</p>	<p>Is the resistance less than 10 Ω?</p>	<p>Go to step 4.</p>	<p>Go to step 5.</p>
<p>4 CHECK AIRBAG MAIN HARNESS AND FRONT SUB-SENSOR HARNESS (LH). Measure the resistance between connector (3I) in test harness I or I2 and the chassis ground.</p> <p>Connector & terminal (3I) No. 3 — Chassis ground: (3I) No. 1 — Chassis ground:</p>	<p>Is the resistance more than 1 MΩ?</p>	<p>LHD MODL: Go to step 9. RHD MODEL: Finish the diagnosis.</p>	<p>LHD MODL: Go to step 5. RHD MODEL: Replace the front sub-sensor (LH). <Ref. to AB-19, Front Sub Sensor.></p>
<p>5 CHECK AIRBAG MAIN HARNESS. 1) Disconnect connector (AB11) from (AB12), and connect connector (1F) in test harness F to (AB11). 2) Measure the resistance between connector (3I) in test harness I or I2 and connector (3F) in test harness F.</p> <p>Connector & terminal (3I) No. 3 — (3F) No. 3: (3I) No. 1 — (3F) No. 4:</p>	<p>Is the resistance less than 10 Ω?</p>	<p>Go to step 6.</p>	<p>Replace the body harness with airbag main harness.</p>

DIAGNOSTIC CHART WITH TROUBLE CODE

AIRBAG SYSTEM (DIAGNOSTICS)

Step	Check	Yes	No
6 CHECK AIRBAG MAIN HARNESS. Measure the resistance between connector (3I) in the test harness I or I2 and the chassis ground. Connector & terminal <i>(3I) No. 3 — Chassis ground:</i> <i>(3I) No. 1 — Chassis ground:</i>	Is the resistance more than 1 M Ω ?	Go to step 7.	Replace the body harness with air-bag main harness.
7 CHECK FRONT SUB-SENSOR HARNESS (LH). 1)Connect connector (2F) in test harness F to connector (AB12). 2)Measure the resistance between connector (3H) in test harness H and connector (3F) in test harness F. Connector & terminal <i>(3F) No. 5 — (3H) No. 5:</i> <i>(3F) No. 6 — (3H) No. 6:</i>	Is the resistance less than 10 Ω ?	Go to step 8.	Replace the body harness with front sub-sensor harness (LH).
8 CHECK FRONT SUB-SENSOR HARNESS (LH). Measure the resistance between connector (3F) in test harness F and the chassis ground. Connector & terminal <i>(3F) No. 5 — Chassis ground:</i> <i>(3F) No. 6 — Chassis ground:</i>	Is the resistance more than 1 M Ω ?	Go to step 9.	Replace the body harness with front sub-sensor harness (LH).
9 CHECK FRONT SUB-SENSOR (LH). 1)Connect connector (2H) in test harness H to front sub-sensor (LH). 2)Measure the resistance of the connector (3H) in test harness H. Connector & terminal <i>(3H) No. 3 — No. 4:</i>	Is the resistance between 750 Ω and 1 K Ω ?	Go to step 10.	Replace the front sub-sensor (LH). <Ref. to AB-19, Front Sub Sensor.>
10 CHECK FRONT SUB-SENSOR (LH). Measure the resistance between connector (3H) in test harness H and the chassis ground. Connector & terminal <i>(3H) No. 3 — Chassis ground:</i> <i>(3H) No. 4 — Chassis ground:</i>	Is the resistance more than 1 M Ω ?	Finish the diagnosis.	Replace the front sub-sensor (LH). <Ref. to AB-19, Front Sub Sensor.>

DIAGNOSTIC CHART WITH TROUBLE CODE

AIRBAG SYSTEM (DIAGNOSTICS)

DIAGNOSTIC CHART WITH TROUBLE CODE

AIRBAG SYSTEM (DIAGNOSTICS)

L: TROUBLE CODE 41

DIAGNOSIS:

- Side airbag harness (RH) is faulty.
- Side airbag module (RH) is faulty.
- Airbag control module is faulty.

CAUTION:

- Before diagnosing the airbag system, be sure to turn the ignition switch OFF, disconnect the ground cable from the battery, and wait more than 20 seconds before starting to work.
- Before replacing the airbag module, roll connector, control module, and sensor, reconnect each part and confirm that the warning light operates properly.
- When inspecting the airbag main harness, disconnect the driver's airbag module and passenger's airbag module connectors for safety reasons.
- When inspecting the side airbag harness, disconnect the side airbag module connector and seat belt pretensioner connector for the safety reasons.

WIRING DIAGRAM:

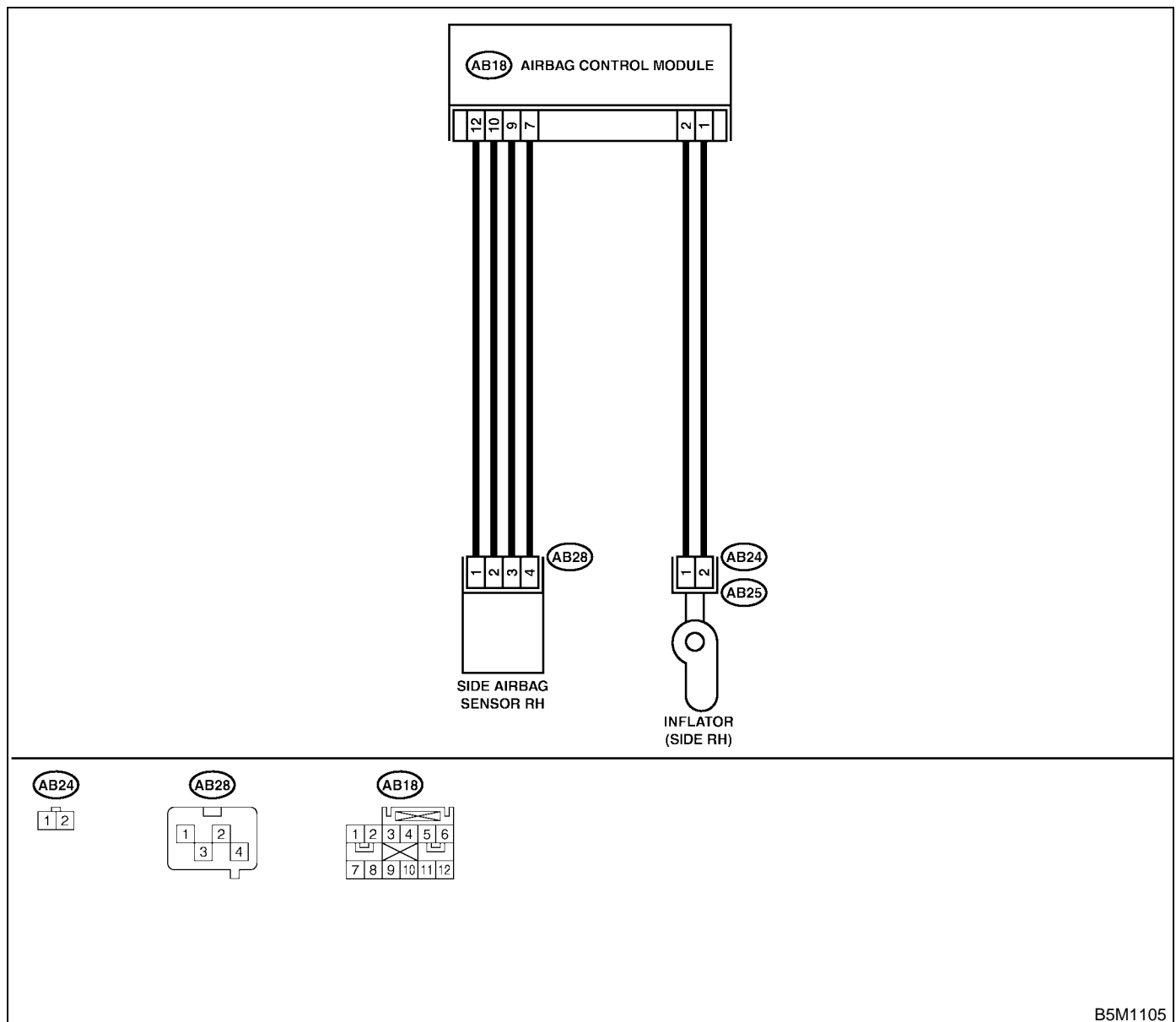

B5M1105

DIAGNOSTIC CHART WITH TROUBLE CODE

AIRBAG SYSTEM (DIAGNOSTICS)

Step	Check	Yes	No
1 CHECK SIDE AIRBAG MODULE. 1) Turn the ignition switch OFF, disconnect the battery ground cable, and wait more than 20 seconds. 2) Disconnect the connector (AB26) from the seat belt pretensioner (RH). <Ref. to SB-8, Front Seat Belt.> 3) Disconnect connector (AB25) from (AB24), and connect connector (1F) in test harness F to (AB24). 4) Connect airbag resistor to connector (3F) in test harness F. 5) Connect the battery ground cable, and turn the ignition switch ON.	Does the airbag warning light operate properly?	Replace front seat with side airbag module (RH). <Ref. to SE-6, Front Seat.>	Go to step 2.
2 CHECK SIDE AIRBAG HARNESS (RH). 1) Turn the ignition switch OFF, disconnect the battery ground cable, and wait more than 20 seconds. 2) Disconnect airbag resistor from test harness F. 3) Disconnect the connector (AB18) from air bag control module. <Ref. to AB-16, Airbag Control Module.> 4) Connect connector (1I) in test harness I or I2 to connector (AB18). 5) Measure the resistance between connector (3I) in test harness I or I2 and connector (3F) in test harness F. Connector & terminal (3I) No. 7 — (3F) No. 4: (3I) No. 9 — (3F) No. 3:	Is the resistance less than 10 Ω?	Go to step 3.	Replace the body harness with side airbag harness.
3 CHECK SIDE AIRBAG HARNESS (RH). Measure the resistance of the connector (3I) in test harness I or I2. Connector & terminal (3I) No. 7 — No. 9:	Is the resistance more than 1 MΩ?	Go to step 4.	Replace the body harness with side airbag harness.
4 CHECK SIDE AIRBAG HARNESS (RH). Measure the resistance of the connector (3F) in test harness F. Connector & terminal (3F) No. 3 — No. 4:	Is the resistance more 1MΩ?	Go to step 5.	Replace the body harness with side airbag harness.
5 CHECK SIDE AIRBAG HARNESS (RH). Measure the resistance between connector (3F) in test harness F and the chassis ground. Connector & terminal (3F) No. 3 — Chassis ground: (3F) No. 4 — Chassis ground:	Is the resistance more than 1 MΩ?	Go to step 6.	Replace the body harness with side airbag harness.
6 CHECK SIDE AIRBAG HARNESS (RH). Measure the resistance between connector (3I) in test harness I or I2 and the chassis ground. Connector & terminal (3I) No. 7 — Chassis ground: (3I) No. 9 — Chassis ground:	Is the resistance more than 1 MΩ?	Replace the airbag control module. <Ref. to AB-16, Airbag Control Module.>	Replace the body harness with side airbag harness.

DIAGNOSTIC CHART WITH TROUBLE CODE

AIRBAG SYSTEM (DIAGNOSTICS)

M: TROUBLE CODE 42

DIAGNOSIS:

- Side airbag harness (LH) is faulty.
- Side airbag module (LH) is faulty.
- Airbag control module is faulty.

CAUTION:

- Before diagnosing the airbag system, be sure to turn the ignition switch OFF, disconnect the ground cable from the battery, and wait more than 20 seconds before starting to work.
- Before replacing the airbag module, roll connector, control module, and sensor, reconnect each part and confirm that the warning light operates properly.
- When inspecting the airbag main harness, disconnect the driver's airbag module and passenger's airbag module connectors for safety reasons.
- When inspecting the side airbag harness, disconnect the side airbag module connector and seat belt pretensioner connector for the safety reasons.

WIRING DIAGRAM:

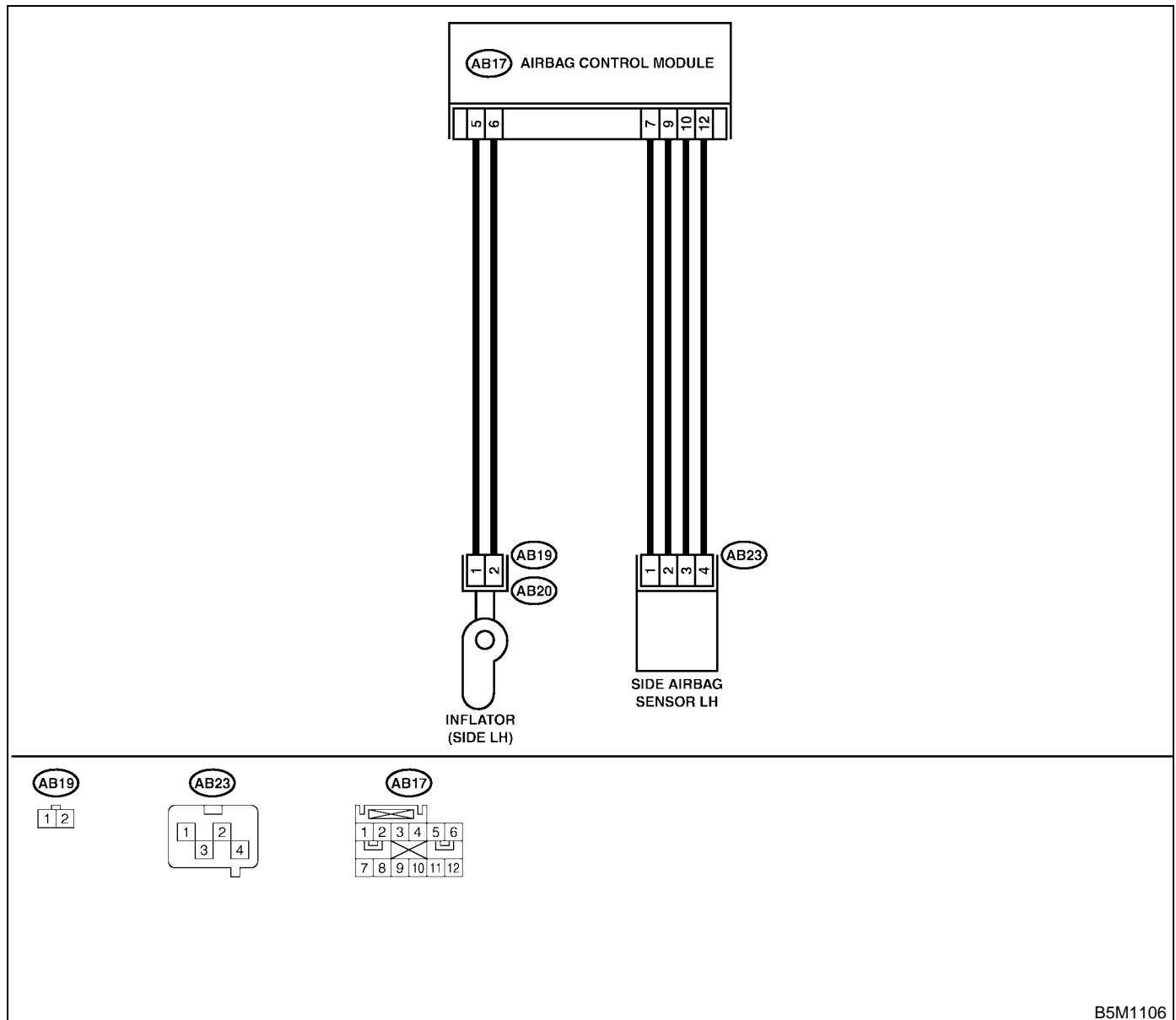

B5M1106

DIAGNOSTIC CHART WITH TROUBLE CODE

AIRBAG SYSTEM (DIAGNOSTICS)

Step	Check	Yes	No
1 CHECK SIDE AIRBAG MODULE. 1) Turn the ignition switch OFF, disconnect the battery ground cable, and wait more than 20 seconds. 2) Disconnect the connector (AB21) from the seat belt pretensioner (LH). <Ref. to SB-8, Front Seat Belt.> 3) Disconnect connector (AB20) from (AB19), and connect connector (1F) in test harness F to (AB19). 4) Connect airbag resistor to connector (3F) in test harness F. 5) Connect the battery ground cable, and turn the ignition switch ON.	Does the airbag warning light operate properly?	Replace front seat with side airbag module (LH). <Ref. to SE-6, Front Seat.>	Go to step 2.
2 CHECK SIDE AIRBAG HARNESS (LH). 1) Turn ignition switch OFF, disconnect the battery ground cable, and wait more than 20 seconds. 2) Disconnect airbag resistor from the test harness. 3) Disconnect the connector (AB17) from the airbag control module. <Ref. to AB-16, Airbag Control Module.> 4) Connect connector (1I) in test harness I or I2 to connector (AB17). 5) Measure the resistance between connector (3I) in test harness I or I2 and connector (3F) in test harness F. Connector & terminal (3I) No. 10 — (3F) No. 3: (3I) No. 12 — (3F) No. 4:	Is the resistance less than 10 Ω?	Go to step 3.	Replace the body harness with side airbag harness.
3 CHECK SIDE AIRBAG HARNESS (LH). Measure the resistance of the connector (3I) in test harness I or I2. Connector & terminal (3I) No. 10 — No. 12:	Is the resistance more than 1 MΩ?	Go to step 4.	Replace the body harness with side airbag harness.
4 CHECK SIDE AIRBAG HARNESS (LH). Measure the resistance of the connector (3F) in test harness F. Connector & terminal (3F) No. 3 — No. 4:	Is the resistance more than 1 MΩ?	Go to step 5.	Replace the body harness with side airbag harness.
5 CHECK SIDE AIRBAG HARNESS (LH). Measure the resistance between connector (3F) in test harness F and the chassis ground. Connector & terminal (3F) No. 3 — Chassis ground: (3F) No. 4 — Chassis ground:	Is the resistance more than 1 MΩ?	Go to step 6.	Replace the body harness with side airbag harness.
6 CHECK SIDE AIRBAG HARNESS (LH). Measure the resistance between connector (3I) in test harness I or I2 and the chassis ground. Connector & terminal (3I) No. 10 — Chassis ground: (3I) No. 12 — Chassis ground:	Is the resistance more than 1 MΩ?	Replace airbag control module. <Ref. to AB-16, Airbag Control Module.>	Replace the body harness with side airbag harness.

DIAGNOSTIC CHART WITH TROUBLE CODE

AIRBAG SYSTEM (DIAGNOSTICS)

N: TROUBLE CODE 45

DIAGNOSIS:

- Side airbag harness (RH) is shorted to power supply.
- Airbag control module is faulty.

CAUTION:

- Before diagnosing the airbag system, be sure to turn the ignition switch OFF, disconnect the ground cable from the battery, and wait more than 20 seconds before starting to work.
- Before replacing the airbag module, roll connector, control module, and sensor, reconnect each part and confirm that the warning light operates properly.
- When inspecting the airbag main harness, disconnect the driver's airbag module and passenger's airbag module connectors for safety reasons.
- When inspecting the side airbag harness, disconnect the side airbag module connector and seat belt pretensioner connector for the safety reasons.

WIRING DIAGRAM:

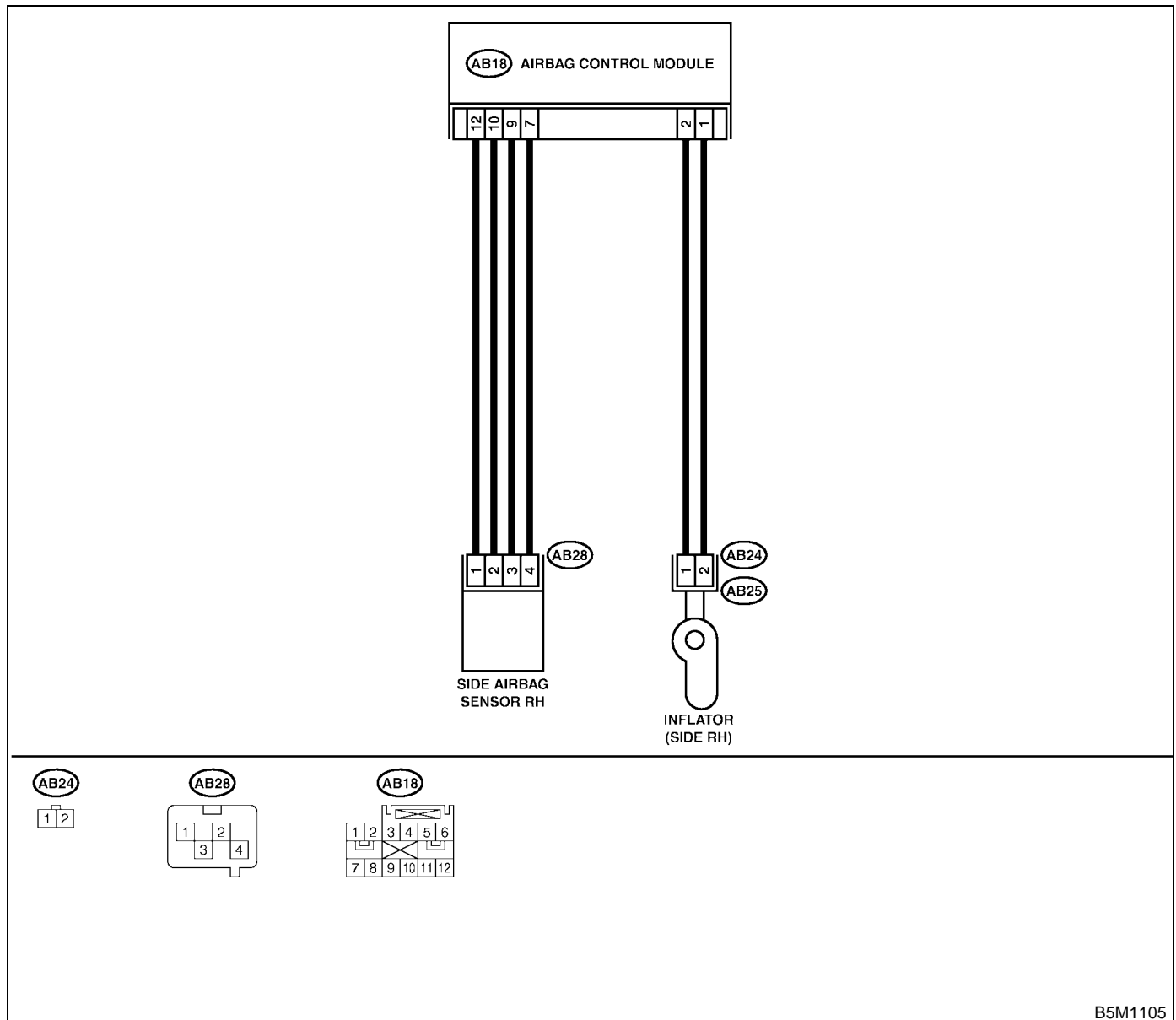

B5M1105

DIAGNOSTIC CHART WITH TROUBLE CODE

AIRBAG SYSTEM (DIAGNOSTICS)

Step	Check	Yes	No
<p>1</p> <p>CHECK SIDE AIRBAG MODULE.</p> <p>1) Turn the ignition switch OFF, disconnect the battery ground cable, and wait more than 20 seconds.</p> <p>2) Disconnect the connector (AB26) from the seat belt pretensioner (RH). <Ref. to SB-8, Front Seat Belt.></p> <p>3) Disconnect the connector (AB25) from (AB24), and connect connector (1F) in test harness F to (AB24).</p> <p>4) Connect airbag resistor to connector (3F) in test harness F.</p> <p>5) Connect the battery ground cable, and turn the ignition switch ON.</p>	<p>Does airbag warning light operate properly?</p>	<p>Replace front seat with side airbag module (RH). <Ref. to SE-6, Front Seat.></p>	<p>Go to step 2.</p>
<p>2</p> <p>CHECK SIDE AIRBAG HARNESS (RH).</p> <p>1) Turn the ignition switch OFF, disconnect the battery ground cable, and wait more than 20 seconds.</p> <p>2) Disconnect airbag resistor from the test harness.</p> <p>3) Disconnect the connector (AB18) from the airbag control module. <Ref. to AB-16, Airbag Control Module.></p> <p>4) Connect connector (1I) in test harness I or I2 to connector (AB18).</p> <p>5) Connect the battery ground cable, and turn the ignition switch ON.</p> <p>6) Measure the voltage between connector (3I) in test harness I or I2 and the chassis ground.</p> <p>Connector & terminal</p> <p>(3I) No. 7 (+) — Chassis ground (-):</p> <p>(3I) No. 9 (+) — Chassis ground (-):</p>	<p>Is the voltage less than 1 V?</p>	<p>Replace the airbag control module. <Ref. to AB-16, Airbag Control Module.></p>	<p>Replace the body harness with side airbag harness.</p>

DIAGNOSTIC CHART WITH TROUBLE CODE

AIRBAG SYSTEM (DIAGNOSTICS)

O: TROUBLE CODE 46

DIAGNOSIS:

- Side airbag harness (LH) is shorted to power supply.
- Airbag control module is faulty.

CAUTION:

- Before diagnosing the airbag system, be sure to turn the ignition switch OFF, disconnect the ground cable from the battery, and wait more than 20 seconds before starting to work.
- Before replacing the airbag module, roll connector, control module, and sensor, reconnect each part and confirm that the warning light operates properly.
- When inspecting the airbag main harness, disconnect the driver's airbag module and passenger's airbag module connectors for safety reasons.
- When inspecting the side airbag harness, disconnect the side airbag module connector and seat belt pretensioner connector for the safety reasons.

WIRING DIAGRAM:

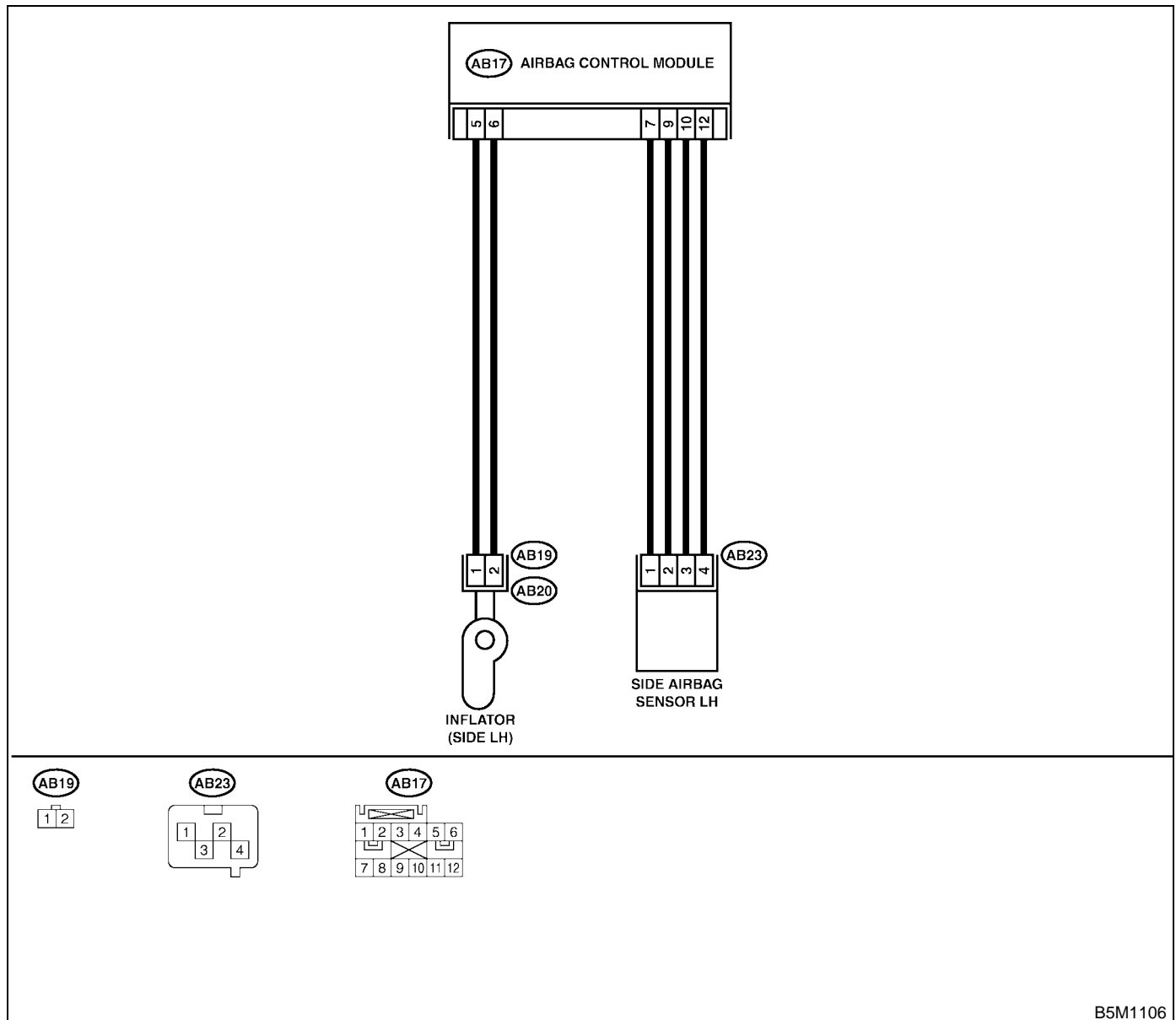

B5M1106

DIAGNOSTIC CHART WITH TROUBLE CODE

AIRBAG SYSTEM (DIAGNOSTICS)

Step	Check	Yes	No
<p>1</p> <p>CHECK SIDE AIRBAG MODULE.</p> <p>1) Turn the ignition switch OFF, disconnect the battery ground cable, and wait more than 20 seconds.</p> <p>2) Disconnect connector (AB21) from the seat belt pretensioner (LH). <Ref. to SB-8, Front Seat Belt.></p> <p>3) Disconnect connector (AB20) from (AB19), and connect connector (1F) in test harness F to (AB19).</p> <p>4) Connect airbag resistor to connector (3F) in test harness F.</p> <p>5) Connect the battery ground cable and turn the ignition switch ON.</p>	<p>Does airbag warning light operate properly?</p>	<p>Replace front seat with side airbag module (LH). <Ref. to SE-6, Front Seat.></p>	<p>Go to step 2.</p>
<p>2</p> <p>CHECK SIDE AIRBAG HARNESS (LH).</p> <p>1) Turn the ignition switch OFF, disconnect the battery ground cable, and wait more than 20 seconds.</p> <p>2) Disconnect airbag resistor from the test harness.</p> <p>3) Disconnect the connector (AB17) from the airbag control module. <Ref. to AB-16, Airbag Control Module.></p> <p>4) Connect connector (1I) in test harness I or I2 to connector (AB17).</p> <p>5) Connect the battery ground cable, and turn the ignition switch ON.</p> <p>6) Measure the voltage between connector (3I) in test harness I or I2 and the chassis ground.</p> <p>Connector & terminal</p> <p>(3I) No. 10 (+) — Chassis ground (-):</p> <p>(3I) No. 12 (+) — Chassis ground (-):</p>	<p>Is the voltage less than 1 V?</p>	<p>Replace the airbag control module. <Ref. to AB-16, Airbag Control Module.></p>	<p>Replace the body harness with side airbag harness.</p>

DIAGNOSTIC CHART WITH TROUBLE CODE

AIRBAG SYSTEM (DIAGNOSTICS)

P: TROUBLE CODE 51

DIAGNOSIS:

- Side airbag sensor (RH) is faulty.
- Side airbag harness (RH) is faulty.
- Airbag control module is faulty.

CAUTION:

- Before diagnosing the airbag system, be sure to turn the ignition switch OFF, disconnect the ground cable from the battery, and wait more than 20 seconds before starting to work.
- Before replacing the airbag module, roll connector, control module, and sensor, reconnect each part and confirm that the warning light operates properly.
- When inspecting the airbag main harness, disconnect the driver's airbag module and passenger's airbag module connectors for safety reasons.
- When inspecting the side airbag harness, disconnect the side airbag module connector and seat belt pretensioner connector for the safety reasons.

WIRING DIAGRAM:

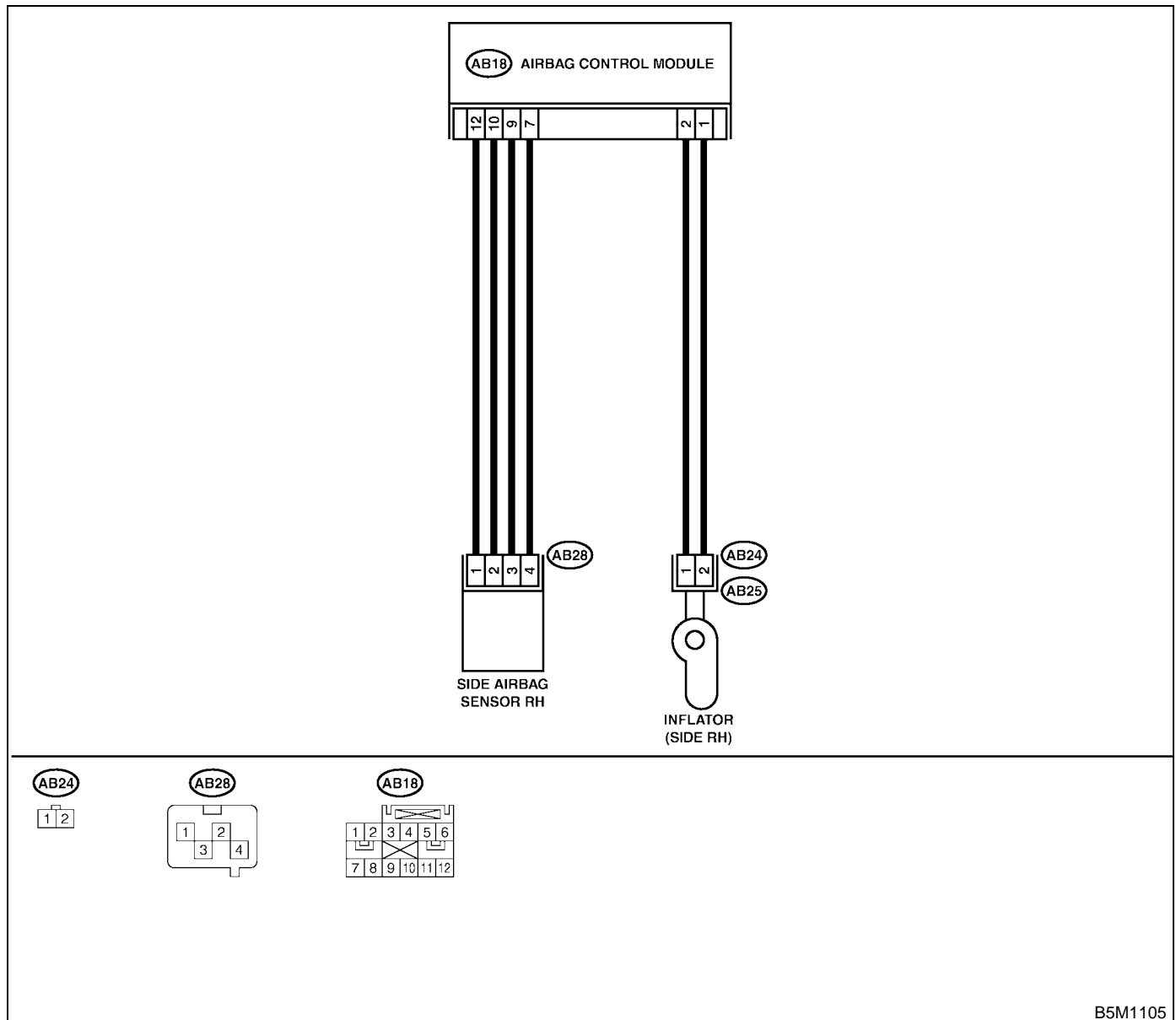

B5M1105

DIAGNOSTIC CHART WITH TROUBLE CODE

AIRBAG SYSTEM (DIAGNOSTICS)

Step	Check	Yes	No
<p>1</p> <p>CHECK SIDE AIRBAG HARNESS (RH). 1) Turn the ignition switch OFF, disconnect the battery ground cable, and wait more than 20 seconds. 2) Disconnect connector (AB26) from the seat belt pretensioner (RH). <Ref. to SB-8, Front Seat Belt.> 3) Disconnect connector (AB25) from (AB24). 4) Disconnect connector (AB18) from the airbag control module. <Ref. to AB-16, Airbag Control Module.> 5) Connect connector (1I) in test harness I or I2 to the connector (AB18). 6) Disconnect connector (AB28) from the side airbag sensor (RH), and connect connector (1G) in test harness G to connector (AB28). 7) Measure the resistance between connector (3I) in test harness I or I2 and connector (3G) in test harness G.</p> <p>Connector & terminal (3I) No. 17 — (3G) No. 2: (3I) No. 18 — (3G) No. 1: (3I) No. 19 — (3G) No. 5: (3I) No. 20 — (3G) No. 4:</p>	<p>Is the resistance less than 10 Ω?</p>	<p>Go to step 2.</p>	<p>Replace the body harness with side airbag harness.</p>
<p>2</p> <p>CHECK SIDE AIRBAG HARNESS (RH). Measure the resistance between connector (3I) in test harness I or I2 and the chassis ground.</p> <p>Connector & terminal (3I) No. 17 — Chassis ground: (3I) No. 18 — Chassis ground: (3I) No. 19 — Chassis ground: (3I) No. 20 — Chassis ground:</p>	<p>Is the resistance more than 1 MΩ?</p>	<p>Replace side airbag sensor (RH). <Ref. to AB-17, Side Airbag Sensor.> When sensor replacement is not OK, replace the airbag control module. <Ref. to AB-16, Airbag Control Module.></p>	<p>Replace the body harness with side airbag harness.</p>

DIAGNOSTIC CHART WITH TROUBLE CODE

AIRBAG SYSTEM (DIAGNOSTICS)

Q: TROUBLE CODE 52

DIAGNOSIS:

- Side airbag sensor (LH) is faulty.
- Side airbag harness (LH) is faulty.
- Airbag control module is faulty.

CAUTION:

- Before diagnosing the airbag system, be sure to turn the ignition switch OFF, disconnect the ground cable from the battery, and wait more than 20 seconds before starting to work.
- Before replacing the airbag module, roll connector, control module, and sensor, reconnect each part and confirm that the warning light operates properly.
- When inspecting the airbag main harness, disconnect the driver's airbag module and passenger's airbag module connectors for safety reasons.
- When inspecting the side airbag harness, disconnect the side airbag module connector and seat belt pretensioner connector for the safety reasons.

WIRING DIAGRAM:

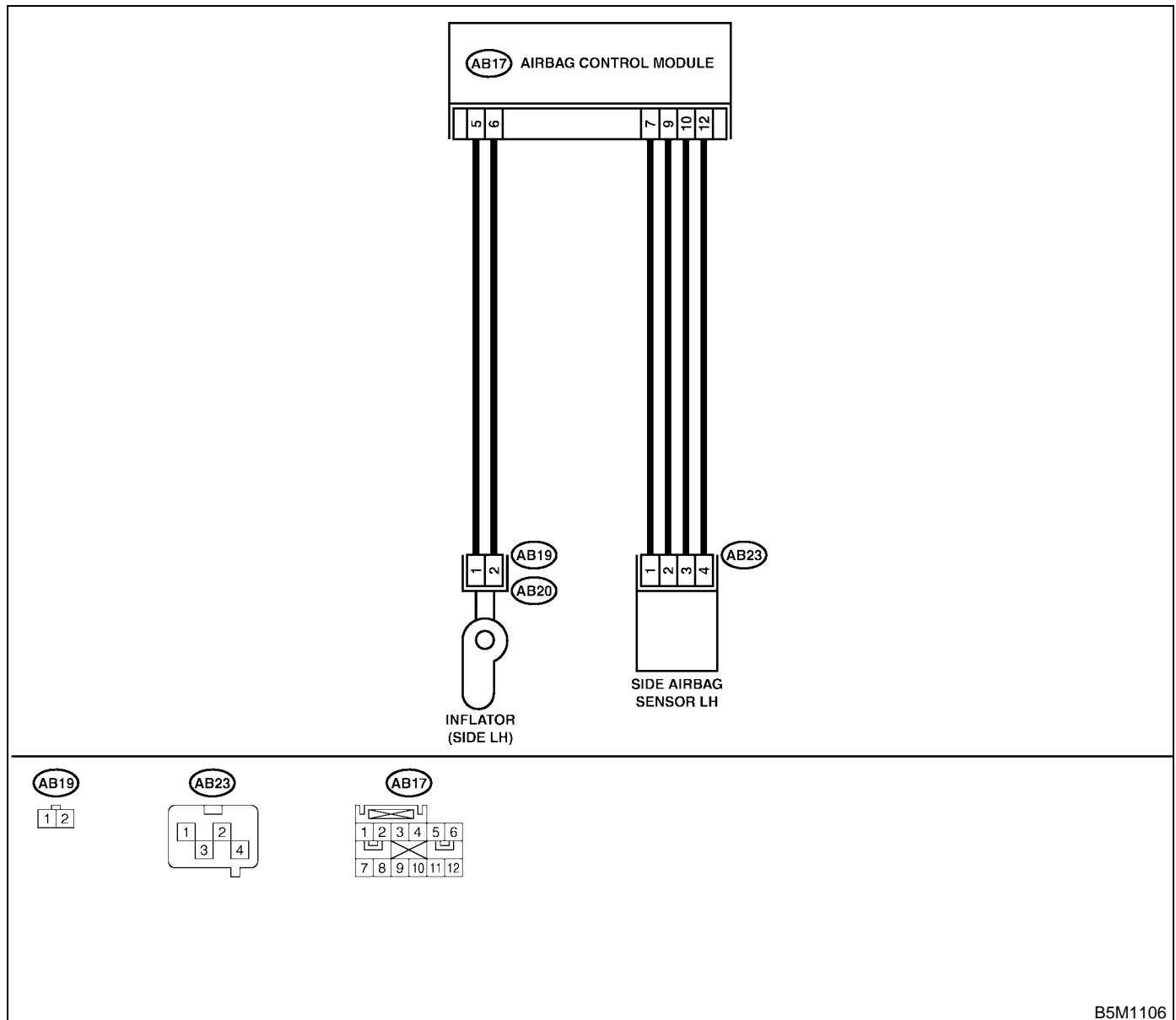

B5M1106

DIAGNOSTIC CHART WITH TROUBLE CODE

AIRBAG SYSTEM (DIAGNOSTICS)

Step	Check	Yes	No
<p>1 CHECK SIDE AIRBAG HARNESS (LH). 1) Turn the ignition switch OFF, disconnect the battery ground cable, and wait more than 20 seconds. 2) Disconnect the connector (AB21) from the seat belt pretensioner (LH). <Ref. to SB-8, Front Seat Belt.> 3) Disconnect connector (AB20) from (AB19). 4) Disconnect connector (AB17) from the airbag control module. <Ref. to AB-16, Airbag Control Module.> 5) Connect connector (1I) in test harness I or I2 to connector (AB17). 6) Disconnect connector (AB23) from the side airbag sensor (LH), and connect connector (1G) in test harness G to connector (AB23). 7) Measure the resistance between connector (3I) in test harness I or I2 and connector (3G) in test harness G.</p> <p>Connector & terminal (3I) No. 5 — (3G) No. 4: (3I) No. 14 — (3G) No. 5: (3I) No. 15 — (3G) No. 1: (3I) No. 16 — (3G) No. 2:</p>	<p>Is the resistance less than 10 Ω?</p>	<p>Go to step 2.</p>	<p>Replace the body harness with side airbag harness.</p>
<p>2 CHECK SIDE AIRBAG HARNESS (RH). Measure the resistance between connector (3I) in test harness I or I2 and the chassis ground.</p> <p>Connector & terminal (3I) No. 5 — Chassis ground: (3I) No. 14 — Chassis ground: (3I) No. 15 — Chassis ground: (3I) No. 16 — Chassis ground:</p>	<p>Is the resistance more than 1 MΩ?</p>	<p>Replace side airbag sensor (LH). <Ref. to AB-17, Side Airbag Sensor.> When sensor replacement is not OK, replace the airbag control module. <Ref. to AB-16, Airbag Control Module.></p>	<p>Replace the body harness with side airbag harness.</p>

R: TROUBLE CODE 53

DIAGNOSIS:

- Side airbag sensor (RH) is faulty.

When Code 53 is displayed, the circuit within the side airbag sensor (RH) is faulty. Replace the side airbag sensor (RH).

<Ref. to AB-17, Side Airbag Sensor.>

S: TROUBLE CODE 54

DIAGNOSIS:

- Side airbag sensor (LH) is faulty.

When Code 53 is displayed, the circuit within the side airbag sensor (LH) is faulty. Replace the side airbag sensor (LH).

<Ref. to AB-17, Side Airbag Sensor.>

T: TROUBLE CODE 55

This code is displayed when the side airbag is deployed.

When this code is displayed, the memory cannot be erased. Replace the following parts.

- Airbag control module. <Ref. to AB-16, Airbag Control Module.>
- Front seat with side airbag module. (Operating side) <Ref. to SE-6, Front Seat.>
- Side airbag sensor. (Operating side) <Ref. to AB-17, Side Airbag Sensor.>

DIAGNOSTIC CHART WITH TROUBLE CODE

AIRBAG SYSTEM (DIAGNOSTICS)

U: TROUBLE CODE 61

DIAGNOSIS:

- Seat belt pretensioner (RH) circuit is open, shorted or shorted to ground.
- Airbag control module is faulty.
- Pretensioner is faulty.
- Pretensioner harness is faulty.

CAUTION:

- Before diagnosing the airbag system, be sure to turn the ignition switch OFF, disconnect the ground cable from the battery, and wait more than 20 seconds before starting to work.
- Before replacing the airbag module, roll connector, control module, and sensor, reconnect each part and confirm that the warning light operates properly.
- When inspecting the side airbag harness, disconnect the side airbag module connector and seat belt pretensioner connector for the safety reasons.

WIRING DIAGRAM:

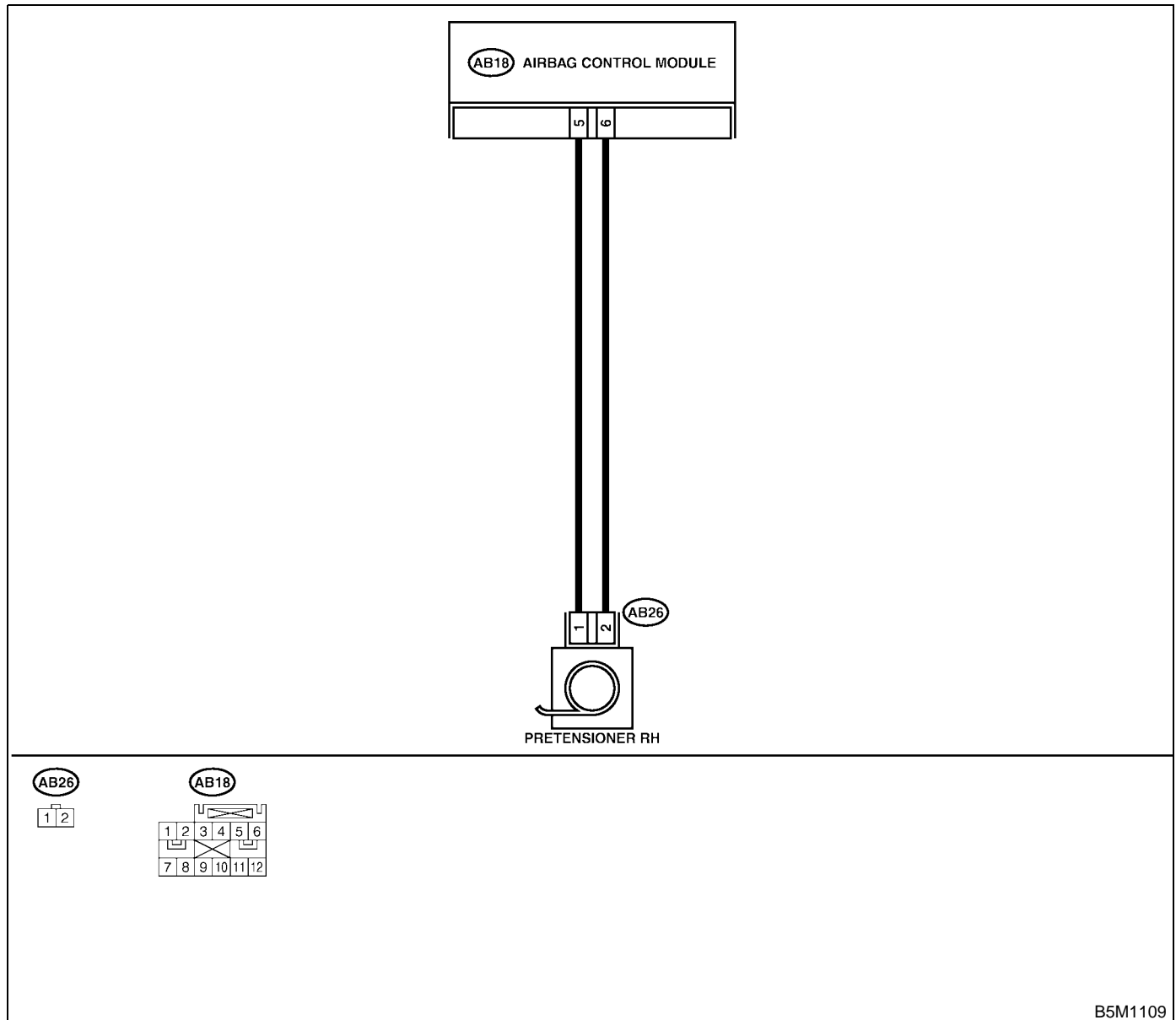

B5M1109

DIAGNOSTIC CHART WITH TROUBLE CODE

AIRBAG SYSTEM (DIAGNOSTICS)

Step	Check	Yes	No
1 CHECK SEAT BELT PRETENSIONER. 1) Turn the ignition switch OFF, disconnect the battery ground cable, and wait more than 20 seconds. 2) Disconnect the connector (AB26) from the seat belt pretensioner (RH). <Ref. to SB-8, Front Seat Belt.> 3) Connect the connector (1L) in test harness L to (AB26). 4) Connect the airbag resistor to connector (3L) in test harness L. 5) Connect the battery ground cable and turn the ignition switch ON.	Does the airbag warning light operate properly?	Replace seat belt pretensioner (RH). <Ref. to SB-8, Front Seat Belt.>	Go to step 2.
2 CHECK SIDE AIRBAG HARNESS (RH). 1) Turn the ignition switch OFF, disconnect the battery ground cable, and wait more than 20 seconds. 2) Disconnect the airbag resistor from the test harness. 3) Disconnect the connector (AB25) from (AB24). 4) Disconnect the connectors (AB17) and (AB18) from the airbag control module. <Ref. to AB-16, Airbag Control Module.> 5) Connect the connector (1I) in test harness I or I2 to connector (AB18). 6) Measure the resistance between connector (3I) in test harness I or I2 and connector (3L) in test harness L. Connector & terminal (3I) No. 8 — (3L) No. 6: (3I) No. 6 — (3L) No. 5:	Is the resistance less than 10 Ω?	Go to step 3.	Replace the body harness with side airbag harness.
3 CHECK SIDE AIRBAG HARNESS (RH). Measure the resistance of the connector (3I) in test harness I or I2. Connector & terminal (3I) No. 6 — No. 8:	Is the resistance more than 1 MΩ?	Go to step 4.	Replace the body harness with side airbag harness.
4 CHECK SIDE AIRBAG HARNESS (RH). Measure the resistance between connector (3I) in test harness I or I2 and the chassis ground. Connector & terminal (3I) No. 6 — Chassis ground: (3I) No. 8 — Chassis ground:	Is the resistance more than 1 MΩ?	Replace the airbag control module. <Ref. to AB-16, Airbag Control Module.>	Replace the body harness with side airbag harness.

DIAGNOSTIC CHART WITH TROUBLE CODE

AIRBAG SYSTEM (DIAGNOSTICS)

V: TROUBLE CODE 62

DIAGNOSIS:

- Seat belt pretensioner (LH) circuit is open, shorted or shorted to ground.
- Airbag control module is faulty.
- Pretensioner is faulty.
- Pretensioner harness is faulty.

CAUTION:

- Before diagnosing the airbag system, be sure to turn the ignition switch OFF, disconnect the ground cable from the battery, and wait more than 20 seconds before starting to work.
- Before replacing the airbag module, roll connector, control module, and sensor, reconnect each part and confirm that the warning light operates properly.
- When inspecting the side airbag harness, disconnect the side airbag module connector and seat belt pretensioner connector for the safety reasons.

WIRING DIAGRAM:

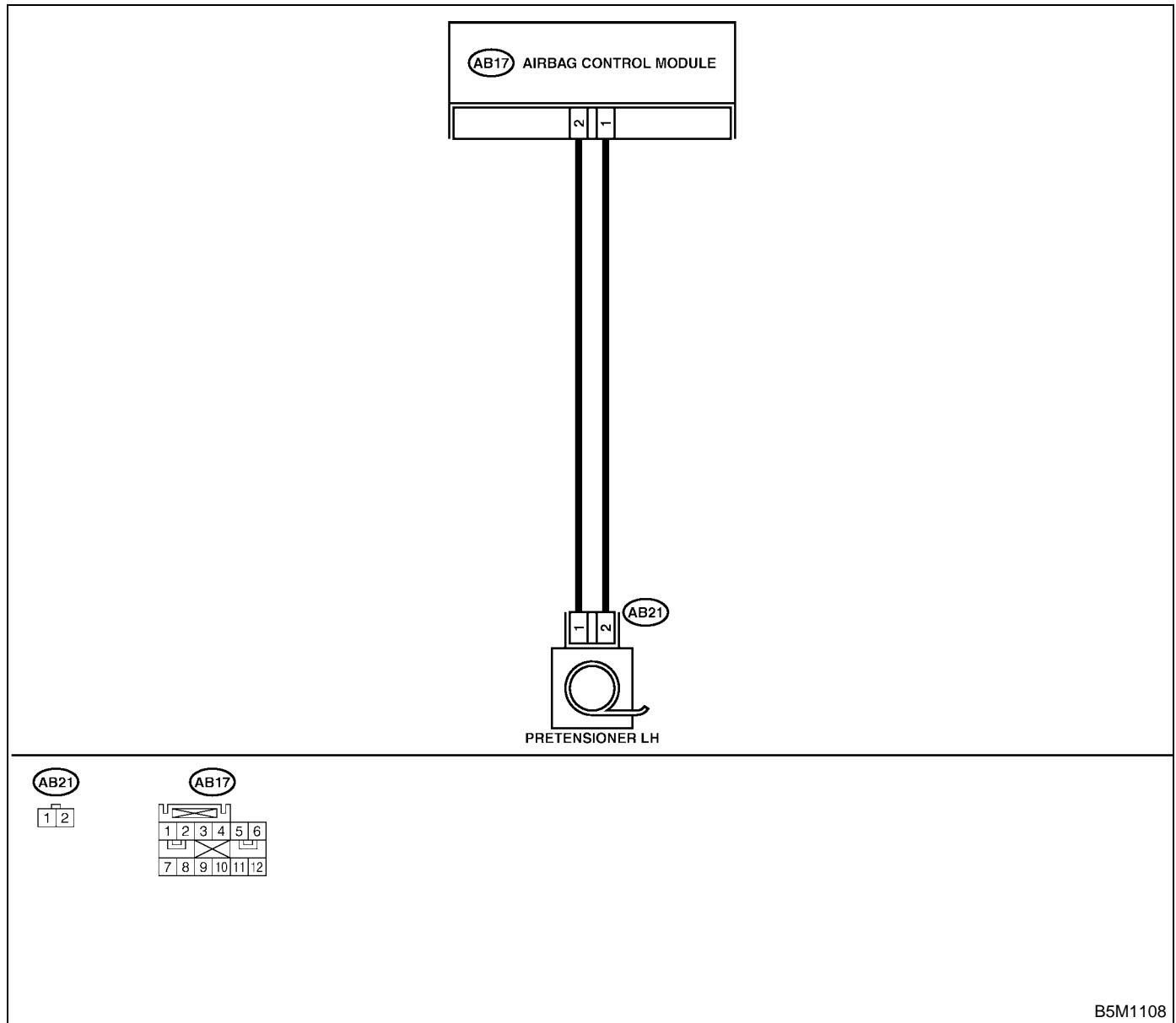

B5M1108

DIAGNOSTIC CHART WITH TROUBLE CODE

AIRBAG SYSTEM (DIAGNOSTICS)

Step	Check	Yes	No
1 CHECK SEAT BELT PRETENSIONER. 1) Turn the ignition switch OFF, disconnect the battery ground cable, and wait more than 20 seconds. 2) Disconnect the connector (AB21) from the seatbelt pretensioner (LH). <Ref. to SB-8, Front Seat Belt.> 3) Connect the connector (1L) in test harness L to (AB21). 4) Connect the airbag resistor to the connector (3L) in test harness L. 5) Connect the battery ground cable and turn the ignition switch ON.	Does the airbag warning light operate properly?	Replace seat belt pretensioner (LH). <Ref. to SB-8, Front Seat Belt.>	Go to step 2.
2 CHECK SIDE AIRBAG HARNESS (LH). 1) Turn the ignition switch OFF, disconnect the battery ground cable, and wait more than 20 seconds. 2) Disconnect the airbag resistor from the test harness. 3) Disconnect the connector (AB20) from (AB19). 4) Disconnect the connectors (AB17) and (AB18) from the airbag control module. <Ref. to AB-16, Airbag Control Module.> 5) Connect the connector (1I) in test harness I or I2 to the connector (AB17). 6) Measure the resistance between connector (3I) in test harness I or I2 and the connector (3L) in test harness L. Connector & terminal (3I) No. 11 — (3L) No. 6: (3I) No. 13 — (3L) No. 5:	Is the resistance less than 10 Ω?	Go to step 3.	Replace the body harness with side airbag harness.
3 CHECK SIDE AIRBAG HARNESS (LH). Measure the resistance of the connector (3I) in test harness I or I2. Connector & terminal (3I) No. 11 — No. 13:	Is the resistance more than 1 MΩ?	Go to step 4.	Replace the body harness with side airbag harness.
4 CHECK SIDE AIRBAG HARNESS (LH). Measure the resistance between the connector (3I) in test harness I or I2 and the chassis ground. Connector & terminal (3I) No. 11 — Chassis ground: (3I) No. 13 — Chassis ground:	Is the resistance more than 1 MΩ?	Replace the airbag control module. <Ref. to AB-16, Airbag Control Module.>	Replace the body harness with side airbag harness.

DIAGNOSTIC CHART WITH TROUBLE CODE

AIRBAG SYSTEM (DIAGNOSTICS)

W: TROUBLE CODE 65

DIAGNOSIS:

- Seat belt pretensioner (RH) circuit is shorted to the power supply.
- Pretensioner is faulty.
- Pretensioner harness is faulty.
- Airbag control module is faulty.

CAUTION:

- Before diagnosing the airbag system, be sure to turn the ignition switch OFF, disconnect the ground cable from the battery, and wait more than 20 seconds before starting to work.
- Before replacing the airbag module, roll connector, control module, and sensor, reconnect each part and confirm that the warning light operates properly.
- When inspecting the side airbag harness, disconnect the side airbag module connector and seat belt pretensioner connector for the safety reasons.

WIRING DIAGRAM:

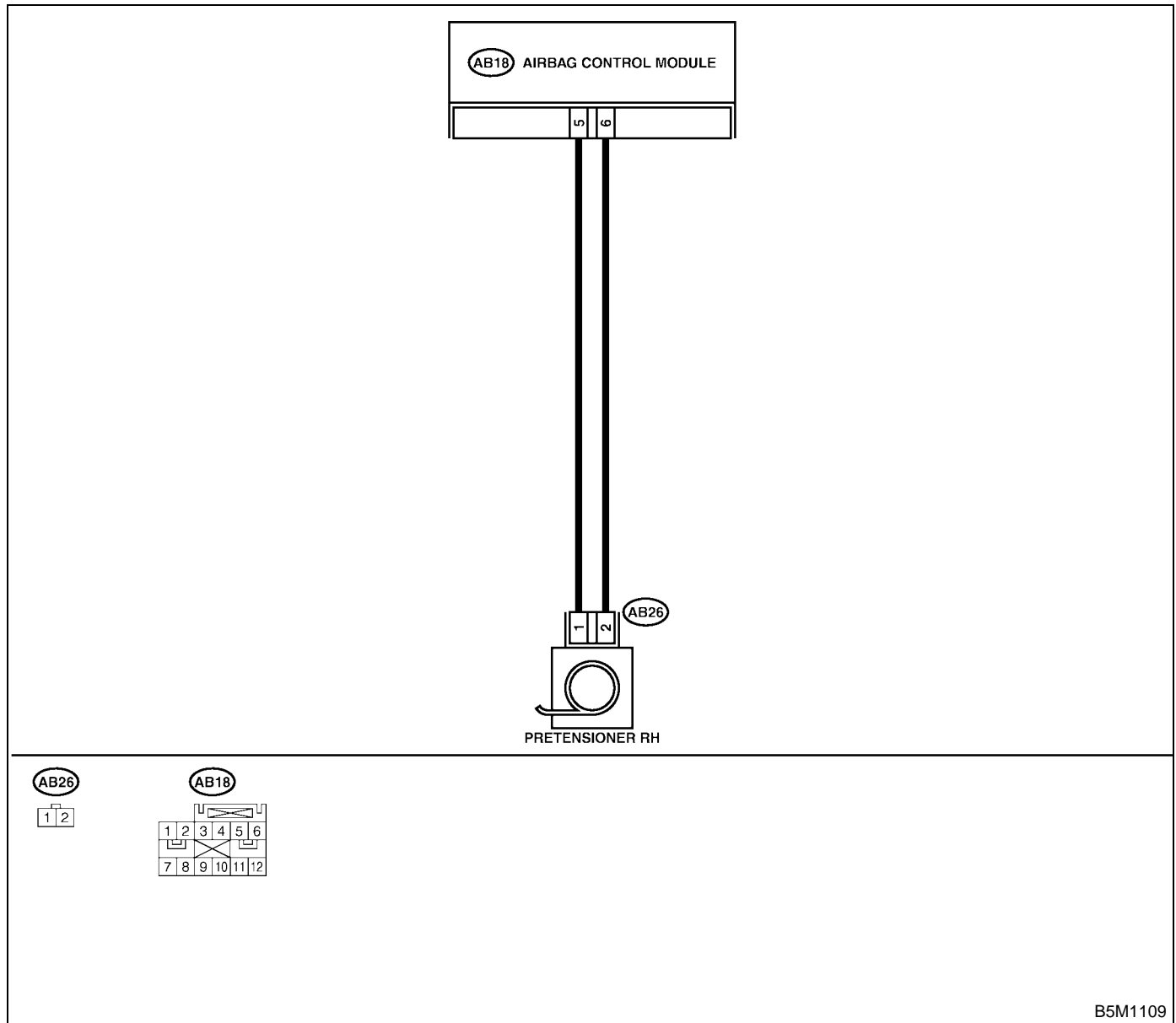

B5M1109

DIAGNOSTIC CHART WITH TROUBLE CODE

AIRBAG SYSTEM (DIAGNOSTICS)

Step	Check	Yes	No
<p>1</p> <p>CHECK SEAT BELT PRETENSIONER.</p> <p>1) Turn the ignition switch OFF, disconnect the battery ground cable, and wait more than 20 seconds.</p> <p>2) Disconnect the connector (AB26) from the seat belt pretensioner (RH). <Ref. to SB-8, Front Seat Belt.></p> <p>3) Connect the connector (1L) in test harness L to (AB26).</p> <p>4) Connect the airbag resistor to connector (3L) in test harness L.</p> <p>5) Connect the battery ground cable, and turn the ignition switch ON.</p>	<p>Does the airbag warning light operate properly?</p>	<p>Replace seat belt pretensioner (RH). <Ref. to SB-8, Front Seat Belt.></p>	<p>Go to step 2.</p>
<p>2</p> <p>CHECK SIDE AIRBAG HARNESS (RH).</p> <p>1) Turn the ignition switch OFF, disconnect the battery ground cable, and wait more than 20 seconds.</p> <p>2) Disconnect the airbag resistor from the test harness.</p> <p>3) Disconnect the connector (AB25) from (AB24).</p> <p>4) Disconnect the connectors (AB17) and (AB18) from the airbag control module. <Ref. to AB-16, Airbag Control Module.></p> <p>5) Connect the connector (1I) in test harness I or I2 to the connector (AB18).</p> <p>6) Connect the battery ground cable and turn the ignition switch ON.</p> <p>7) Measure the voltage between connector (3I) in test harness I or I2 and the chassis ground.</p> <p>Connector & terminal</p> <p>(3I) No. 6 (+) — Chassis ground (-):</p> <p>(3I) No. 8 (+) — Chassis ground (-):</p>	<p>Is the voltage less than 1 V?</p>	<p>Replace the airbag control module. <Ref. to AB-16, Airbag Control Module.></p>	<p>Replace the body harness with side airbag harness.</p>

DIAGNOSTIC CHART WITH TROUBLE CODE

AIRBAG SYSTEM (DIAGNOSTICS)

X: TROUBLE CODE 66

DIAGNOSIS:

- Seat belt pretensioner (LH) circuit is shorted to the power supply.
- Pretensioner is faulty.
- Pretensioner harness is faulty.
- Airbag control module is faulty.

CAUTION:

- Before diagnosing the airbag system, be sure to turn the ignition switch OFF, disconnect the ground cable from the battery, and wait more than 20 seconds before starting to work.
- Before replacing the airbag module, roll connector, control module and the sensor, reconnect each part and confirm that the warning light operates properly.
- When inspecting the side airbag harness, disconnect the side airbag module connector and seat belt pretensioner connector for the safety reasons.

WIRING DIAGRAM:

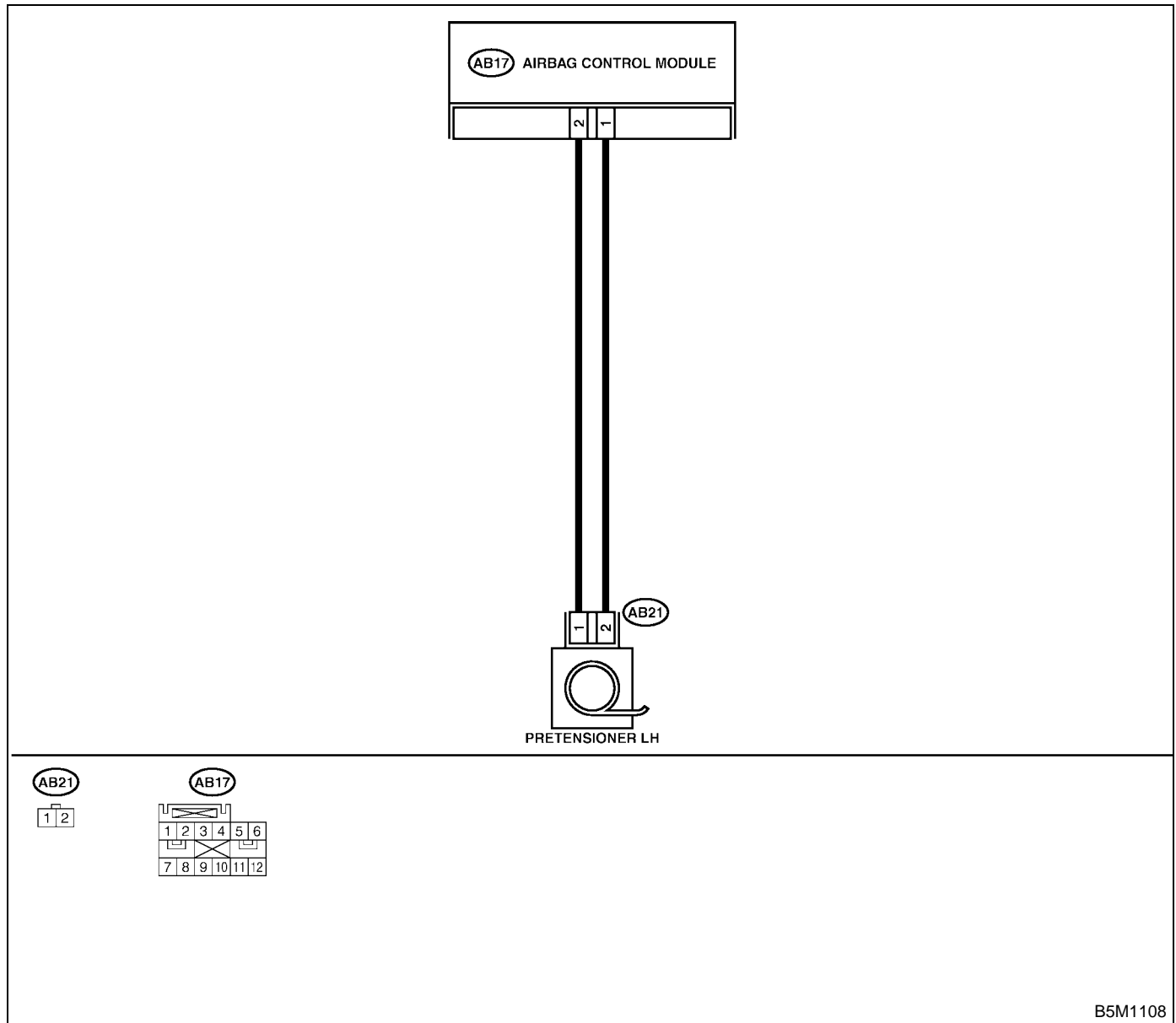

B5M1108

DIAGNOSTIC CHART WITH TROUBLE CODE

AIRBAG SYSTEM (DIAGNOSTICS)

Step	Check	Yes	No
<p>1</p> <p>CHECK SEAT BELT PRETENSIONER.</p> <p>1) Turn the ignition switch OFF, disconnect the battery ground cable, and wait more than 20 seconds.</p> <p>2) Disconnect the connector (AB21) from the seat belt pretensioner (LH). <Ref. to SB-8, Front Seat Belt.></p> <p>3) Connect the connector (1L) in test harness L to (AB21).</p> <p>4) Connect the airbag resistor to the connector (3L) in test harness L.</p> <p>5) Connect the battery ground cable and turn the ignition switch ON.</p>	<p>Does the airbag warning light operate properly?</p>	<p>Replace seat belt pre-tensioner(LH). <Ref. to SB-8, Front Seat Belt.></p>	<p>Go to step 2.</p>
<p>2</p> <p>CHECK SIDE AIRBAG HARNESS (LH).</p> <p>1) Turn the ignition switch OFF, disconnect the battery ground cable, and wait more than 20 seconds.</p> <p>2) Disconnect the airbag resistor from the test harness.</p> <p>3) Disconnect the connector (AB20) from (AB19).</p> <p>4) Disconnect the connectors (AB17) and (AB18) from the airbag control module. <Ref. to AB-16, Airbag Control Module.></p> <p>5) Connect the connector (1I) in test harness I or I2 to the connector (AB17).</p> <p>6) Connect the battery ground cable and turn the ignition switch ON.</p> <p>7) Measure the voltage between connector (3I) in test harness I or I2 and the chassis ground.</p> <p>Connector & terminal</p> <p>(3I) No. 11 (+) — Chassis ground (-):</p> <p>(3I) No. 13 (+) — Chassis ground (-):</p>	<p>Is the voltage less than 1 V?</p>	<p>Replace the airbag control module. <Ref. to AB-16, Airbag Control Module.></p>	<p>Replace the body harness with side airbag harness.</p>

DIAGNOSTIC CHART WITH TROUBLE CODE

AIRBAG SYSTEM (DIAGNOSTICS)
